

Hydronix

Sensor Configuration Software

Hydro-Com

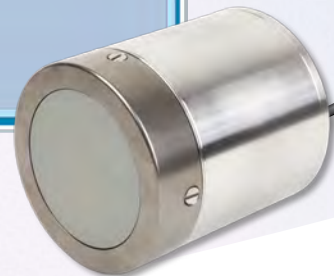
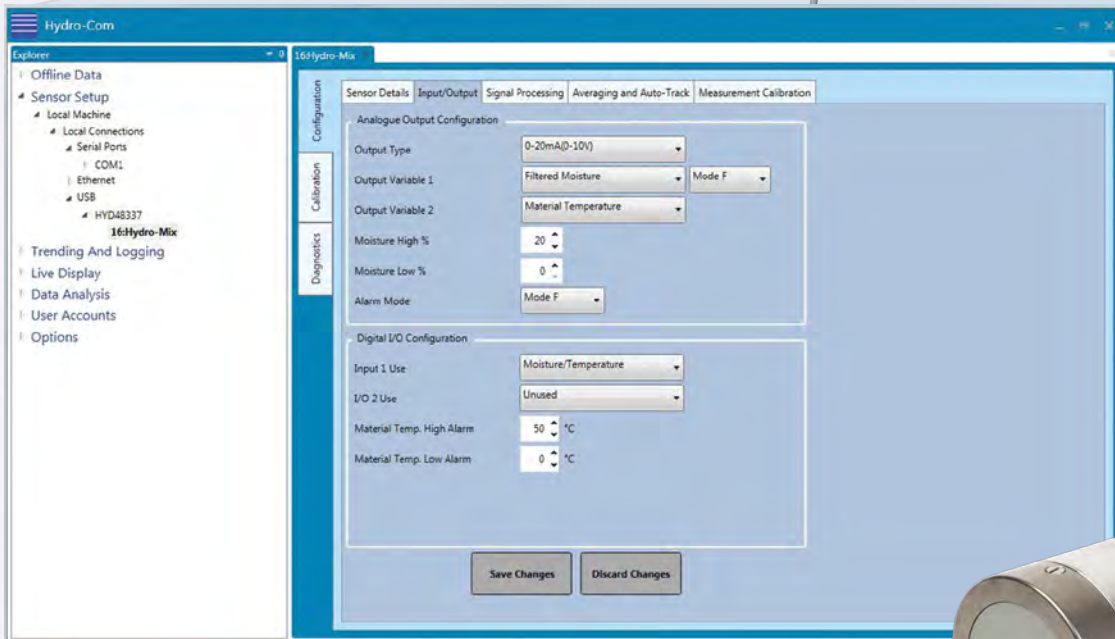

THE ORIGINAL – THE LEADERS – THE BEST

Hydro-Com Software

Calibration and Configuration Software for Hydronix Sensors

Hydro-Com software has been designed to easily configure, calibrate and monitor Hydronix sensors. It provides a solution that is scalable from a user connecting to a single sensor to centrally managing multiple sensors across different sites.

The software allows access to all of the sensor settings, from basic configuration to the use of advanced sensor features. This ensures that you can easily verify that every sensor is optimised and performing as intended.

Connections

View any sensor on the network

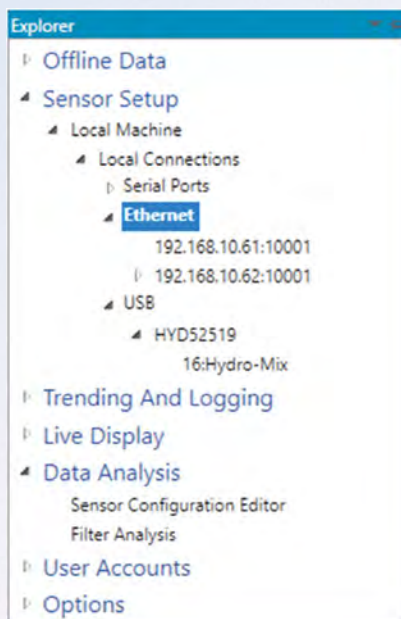

Features

- Easily configure Hydronix sensors.
- Scalable solution from one sensor to a global network.
- Configurable real time display.
- Trending and logging functions.
- Calibration and analysis tools.
- Sensor calibration.
- Sensor configuration check.
- Data analysis tools.
- Offline configuration editor.
- Multi-language, easy to use interface.
- Backup, restore and reset sensor settings.
- Designed to run on Microsoft Windows.

Trending and Logging

Sensor data can be graphically displayed and logged to file for further analysis.

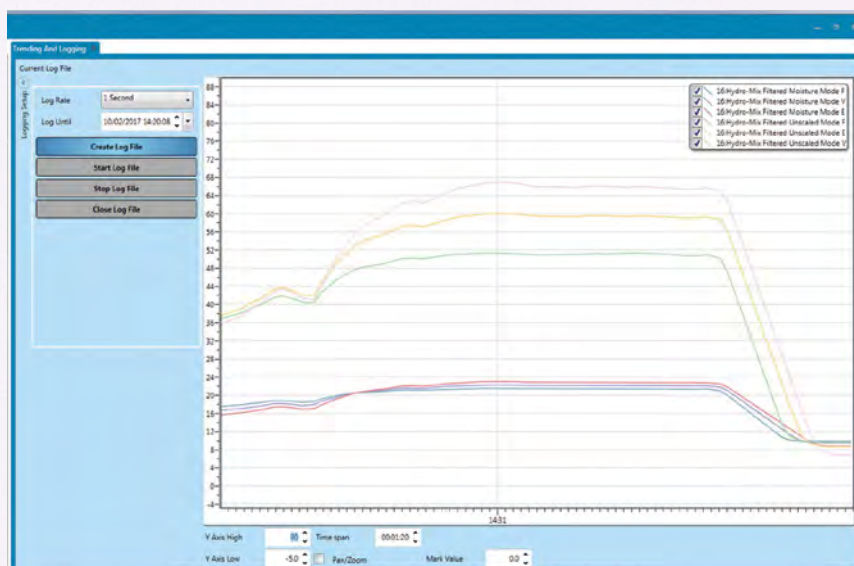

Configuration and Diagnostics

Sensor Configuration

Configure settings to work with any control system.

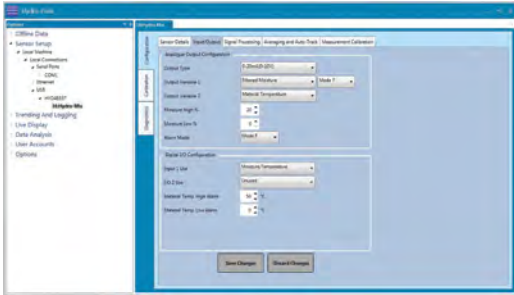

Sensor Diagnostics

Review live sensor data to check sensor functionality.

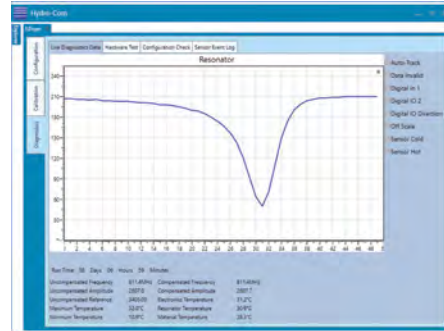

Material Calibration

Measurement Mode Selection

Select the best mode for your material.

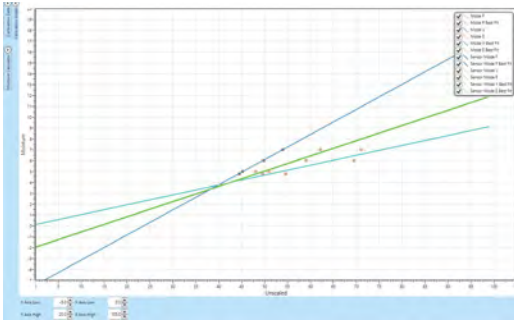

Hydronix sensors may be calibrated to directly output a moisture percentage or Brix value. A simple interface enables the user to select the most appropriate calibration method and to capture, review, verify and store calibration data.

Multiple material calibrations may be stored in Hydro-Com and loaded into the sensor as required.

The performance of each measurement mode may be compared and the best mode selected to achieve the highest possible accuracy.

Process Optimisation

Hydro-Com software enables data to be captured and analysed to get the best performance from the sensor.

Filter Analysis

Optimise sensor filtering parameters.

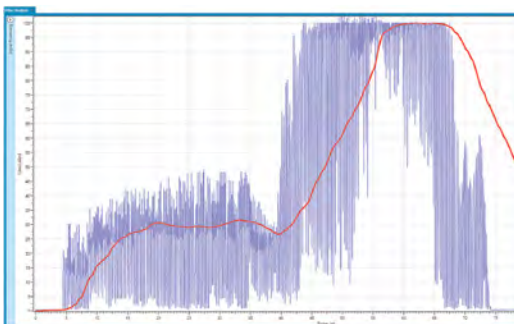

Mode Analysis

Select measurement mode for best performance.

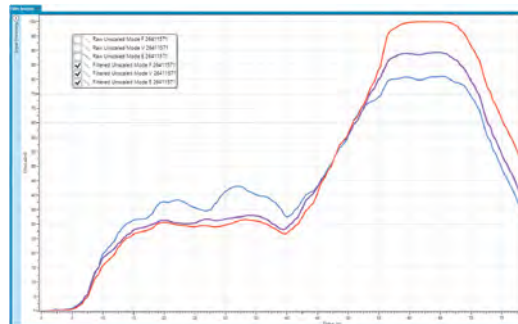

Connection Options

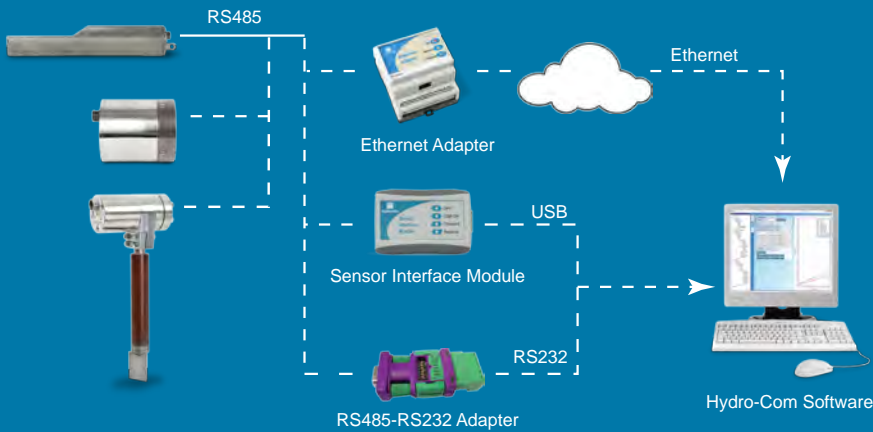

Technical Information

Operating System

Microsoft Windows ≥ XP SP3.

Technology Services

Microsoft .NET Framework.

WCF Services.

SQL Server Compact Database.

Remote Connections

Basic HTTP or WS HTTP.

Internet Connection

Network configuration may be required to enable remote access.

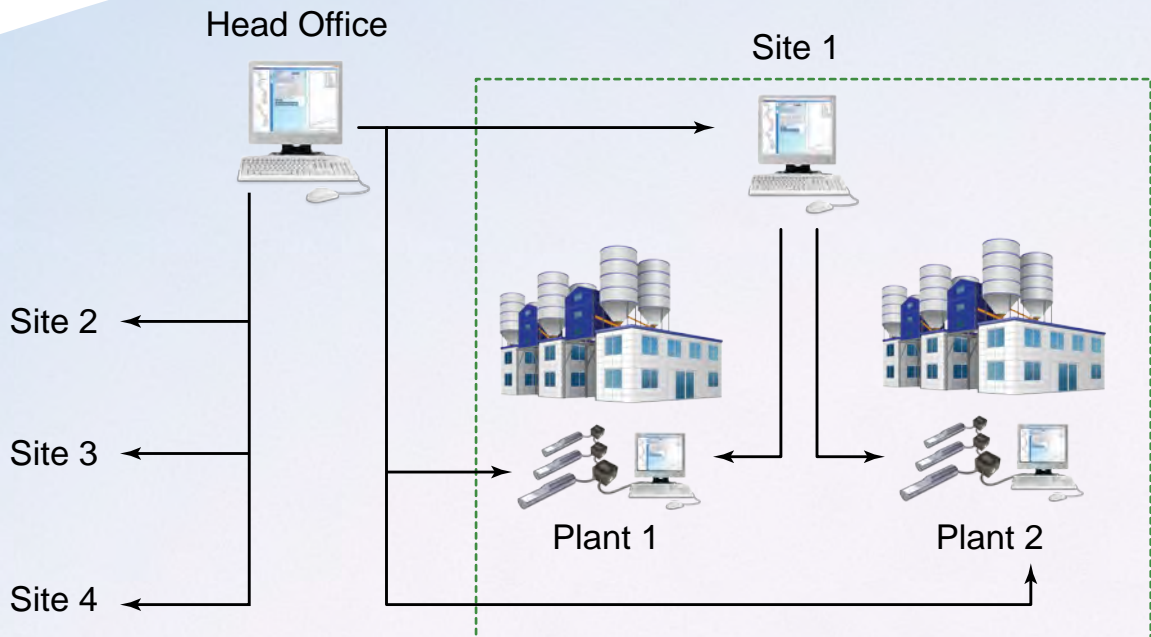

Remote Connections / Multiple Sites



Hydronix

Head Office - United Kingdom:

Tel: +44 (0)1483 468900

Fax: +44 (0)1483 468919

Email: enquiries@hydronix.com

Central Europe & Southern Africa:

Tel: + 49 2563 4858

France:

Tel: + 33 652 04 89 04

America, Spain & Portugal:

Tel: +1 231-439-5000

Hydro-Com has the ability to connect to remote sensors. This enables engineers who are in control of multiple sites to access and update configuration settings and calibration data. Engineers or Quality Control Managers can easily and quickly review the last known calibration data and compare it with current data to identify errors or improvements made to calibrations.

Sensors can be organised by company and site and contact details for personnel can also be stored.

www.hydronix.com