

Hydro-Control V

User Guide

Hydronix Part no: HD0193
Version 2.5.0
Revision date: March 2010

COPYRIGHT

Neither the whole or any part of the information contained in nor the product described in this documentation may be adapted or reproduced in any material form except with the prior written approval of Hydronix Limited, hereinafter referred to as Hydronix.

© 2003 Hydronix Limited
7, Riverside Business Centre, Walnut Tree Close
Guildford
Surrey
GU1 4UG
United Kingdom

All rights reserved

CUSTOMER RESPONSIBILITY

The customer in applying the product described in this documentation accepts that the product is a programmable electronic system which is inherently complex and which may not be completely free of errors. In doing so the customer therefore undertakes responsibility to ensure that the product is properly installed commissioned operated and maintained by competent and suitably trained persons and in accordance with any instructions or safety precautions made available or good engineering practice and to thoroughly verify the use of the product in the particular application.

ERRORS IN DOCUMENTATION

The product described in this documentation is subject to continuous development and improvement. All information of a technical nature and particulars of the product and its use including the information and particulars contained in this documentation are given by Hydronix in good faith.

Hydronix welcomes comments and suggestions relating to the product and this documentation.

This documentation is intended only to assist the reader in the use of the product and therefore Hydronix shall not be liable for any loss or damage howsoever arising from the use of information or particulars in or any error in or omission from this documentation.

ACKNOWLEDGEMENTS

Hydronix, Hydro-Probe, Hydro-Skid, Hydro-Mix, Hydro-View and Hydro-Control are Registered Trade Marks of Hydronix Limited.

Revision History

Issue No	S/W Version	Date	Changes
1.0.0	HS0035 2.12	May 01	Original
1.1.0	HS0035 3.0	Nov 01	Software upgrade. Reference made to Hydro-Probe Orbiter
2.0.0	HS0035 4.10	Oct 03	Software upgrade.
2.1.0	HS0035 4.20	May 04	Software upgrade. Temperature Compensation added. Pre-wet and Final-wet valve selection added.
2.2.0	HS0035 5.00	July 06	Software upgrade.
2.3.0	HS0035 5.00	March 07	Formatting Correction page 87
2.4.0	HS0035 5.00	July 07	User Guide re-indexed
2.4.1	HS0035 5.05	March 10	Modification to OPTO selection and maximum flowmeter frequency

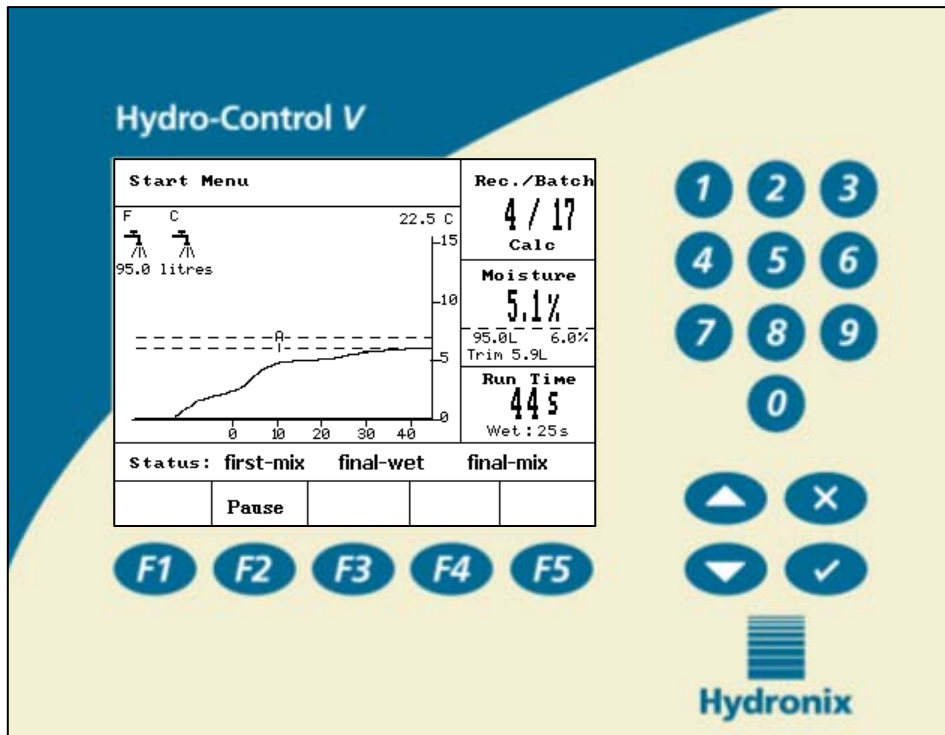

Figure 1 – Hydro-Control V - Front Panel

Table of Contents

TABLE OF FIGURES.....	7
CHAPTER 1 INTRODUCTION.....	9
CHAPTER 2 OPERATION.....	11
BASIC OPERATION OVERVIEW	11
SETTING MIX TIMES.....	13
EDITING RECIPES	14
MIX CONTROL MODES	14
PRESET MODE.....	15
AUTO MODE	17
AUTO MODE CONTROL PARAMETERS	20
CALC MODE.....	22
CHAPTER 3 MENU DESCRIPTION	27
MENU TREE	27
START MENU	28
SELECT RECIPE	30
EDIT RECIPE.....	31
MIXING	36
SYSTEM AUTOMATIC PAUSE AND ALARM	37
TRIM AND UPDATE.....	38
MIX LOG	39
SETUP SYSTEM.....	45
SENSOR CONFIGURATION.....	54
CHAPTER 4 RS232 INTERFACE	57
RS232 CONNECTIONS ON OPERATOR TERMINAL.....	57
SENDING REMOTE COMMANDS	57
CONNECTING TO A PC/LAPTOP	64
UPGRADING SOFTWARE	65
CHAPTER 5 INSTALLATION	67
SAFETY INSTRUCTIONS	67
INSTALLING THE HYDRO-CONTROL V	68
WIRING CONNECTIONS	68
EXPLANATION OF MIX CYCLE.....	73
INPUT AND OUTPUT FUNCTIONS	74
REMOTE SELECTION VIA PLC	81
CHAPTER 6 VALVES AND WATER FLOW RATES.....	85
CHAPTER 7 SPECIFICATIONS	87
APPENDIX A ADVANCED CONTROL PARAMETERS.....	89
APPENDIX B BACKGROUND TO CONTROL METHODS.....	93

AUTO MODE	93
CALC MODE.....	93
APPENDIX C SYSTEM AND CONTROL PARAMETERS RECORD	95
APPENDIX D PASSWORDS	97
APPENDIX E IMPROVING THE PERFORMANCE OF YOUR MIXER	101
APPENDIX F DIAGNOSTICS RECORD	103
INDEX.....	105

Table of Figures

FIGURE 1 – HYDRO-CONTROL V - FRONT PANEL.....	4
FIGURE 2 – ‘PRE-WET’ MIX CYCLE.....	11
FIGURE 3 – ‘DRY MIX’ MIX CYCLE.....	12
FIGURE 4 – PRESET MODE MIX CYCLE.....	15
FIGURE 5 – AUTO MODE MIX CYCLE	17
FIGURE 6 – VALVE CONTROL IN AUTO MODE.....	21
FIGURE 7 – CALC MODE MIX CYCLE.....	22
FIGURE 8 – MENU TREE	27
FIGURE 9 – START MENU.....	28
FIGURE 10 – SELECT RECIPE.....	30
FIGURE 11 – EDIT RECIPE (1 ST PAGE).....	31
FIGURE 12 – EDIT RECIPE (2ND PAGE)	32
FIGURE 13 – EDIT RECIPE (3RD PAGE)	32
FIGURE 14 – COPY RECIPE PAGE	35
FIGURE 15 – MIX CYCLE	36
FIGURE 16 – MIX LOG (SENSOR READINGS)	39
FIGURE 17 – MIX LOG (WATER INFORMATION).....	40
FIGURE 18 – MIX LOG (MIX INFORMATION)	41
FIGURE 19 – MIX LOG (DEVIATION INFORMATION)	42
FIGURE 20 –MIX LOG DEVIATIONS – TREND DISPLAY.....	42
FIGURE 21 – CALIBRATING FROM MIX LOG (ENTER DRY WEIGHT).....	43
FIGURE 22 – CALIBRATING FROM MIX LOG (ENTER FINAL MOISTURE)	44
FIGURE 23 – CALIBRATING FROM MIX LOG (ENTER TRIM WATER).....	44
FIGURE 24 – SETUP SYSTEM.....	45
FIGURE 25 – EDIT SYSTEM	46
FIGURE 26 – CHECKING VALVES	47
FIGURE 27 – CONTROL MENU (FIRST PAGE).....	48
FIGURE 28 – DIAGNOSTICS	50
FIGURE 29 – HARDWARE	51
FIGURE 30 – RESONATOR	52
FIGURE 31 – MONITOR SENSOR READINGS	53
FIGURE 32 – SENSOR CONFIGURATION	54
FIGURE 33 – PRE-WET MIX CYCLE	70
FIGURE 34 – DRY MIX CYCLE (NO PRE-WET).....	71
FIGURE 35 – BUSY SIGNAL	72
FIGURE 36 – SYSTEM BLOCK DIAGRAM.....	77
FIGURE 37 – SYSTEM INTERCONNECTION	78
FIGURE 38 – EXAMPLE WIRING SCHEMATIC FOR MANUAL PLANT OPERATION	79
FIGURE 39 – PANEL CUT-OUT FOR OPERATOR TERMINAL	80
FIGURE 40 – OPERATOR PANEL DIMENSIONS	80
FIGURE 41 – REMOTE RECIPE PLC CONNECTIONS.....	82
FIGURE 42 – REMOTE RECIPE PLC START SIGNAL OPTIONS	83
FIGURE 43 – REMOTE RECIPE PLC DIMENSIONS	84
FIGURE 44 – EDIT ADVANCED CONTROL PARAMETERS SCREEN.....	89
FIGURE 45 – TEST MODE SCREEN	90

Hydro-Control V is an easy to use control system for controlling water addition during concrete mixing. In conjunction with the Hydronix Hydro-Mix V/VI or Hydro-Probe Orbiter it is designed to precisely achieve the required moisture target without the need for metering the water, although use of a water meter is preferred.

From software version HS0035 v. 4.20, the Hydro-Control V has temperature compensation which enables the control of water addition to achieve the required consistency throughout the year, regardless of variation in material temperature.

It is simple to install and can be fitted to both new and existing plants. It uses the latest Hitachi H8 microprocessor with SMD technology to achieve a compact and reliable unit.

The unit contains sophisticated control software to ensure the user can achieve the desired result with the minimum fuss.

The large, clear display ensures the principal information is readily visible without confusion. Via a few easily accessed menus, the user can define the mix cycle and the recipes as well as monitor the mixing cycle status, recipe information, sensor signal trend information and system diagnostics.

The Hydro-Control V can be connected to a batch controller via an RS232 serial link to allow transfer of mix cycle information and remote recipe selection. The RS232 port is also used to send software upgrades from a service computer.

The aim of this User Guide is to provide a simple operational overview followed by a more detailed screen-by-screen explanation of the system operation.

Notes:

Basic operation overview

The Hydro-Control V operation is based on a recipe system. Up to 99 recipes can be defined. Each recipe contains information for running the mix cycle. Before running a mix cycle it is necessary to set up a recipe with the correct values to define the control mode and to control the mix cycle.

There are two basic mix cycles that can be defined: –

'Pre-wet' mix cycle

The Pre-wet mix cycle is used when an amount of water is to be added to the aggregates before cement addition, the **Final wet** (main water addition) occurs after the **First mix time** (often referred to as the dry mix time) and is followed by the **Final mix time** (also known as the wet mix time). At the end of the **Final mix time** a **MIX COMPLETE** signal is issued from the Hydro-Control V and the mixer can be discharged.

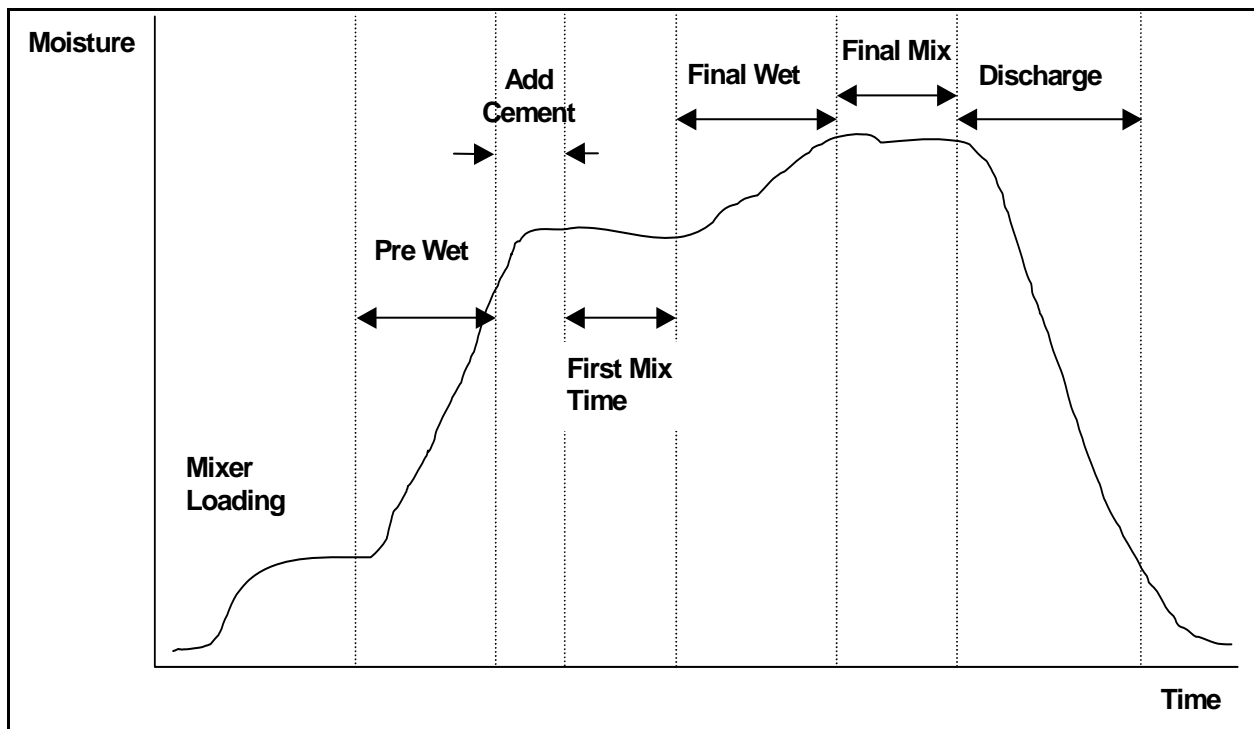

Figure 2 – 'Pre-Wet' Mix Cycle

'Dry Mix' mix cycle

The 'Dry Mix' mix cycle is used when no pre-wet is required. The **Final wet** (main water addition) occurs after the **First mix time** and is followed by the **Final mix time**. At the end of the **Final mix time** a **MIX COMPLETE** signal is issued from the Hydro-Control V and the mixer can be discharged.

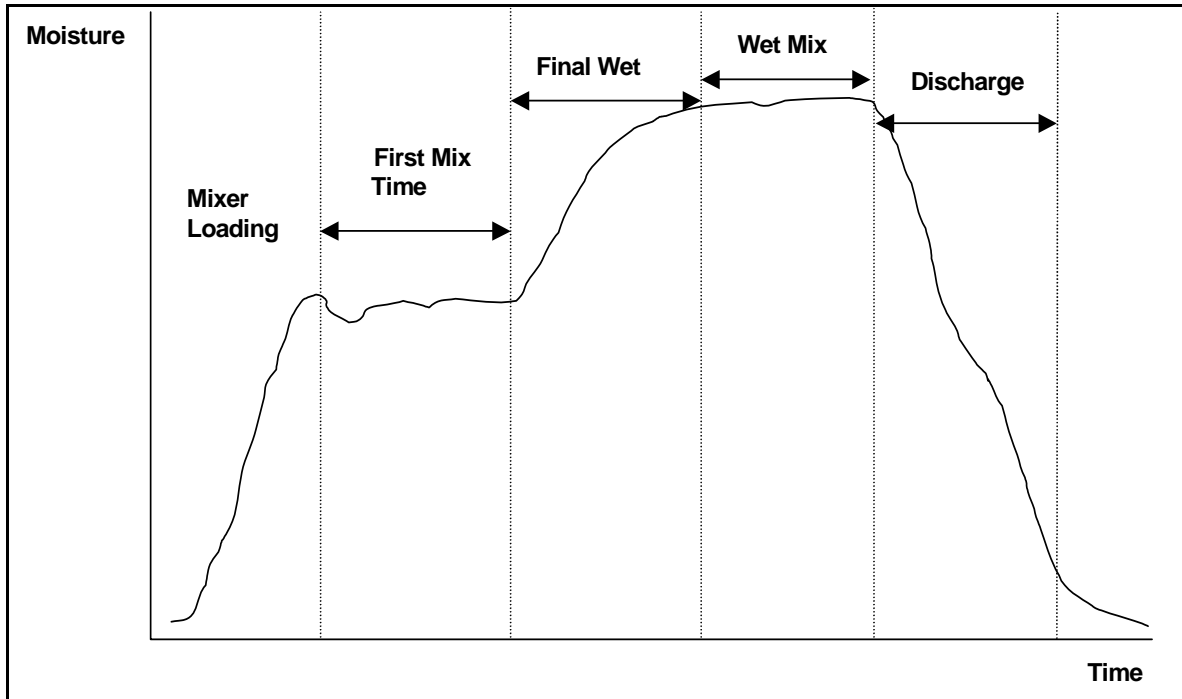

Figure 3 – 'Dry Mix' Mix Cycle

The Hydro-Control V can operate in one of three control modes. The control mode to be used is defined by the recipe and may be different for each recipe.

Preset Mode

A fixed amount of water defined by the recipe is added during both the pre-wet (if required) and final-wet phases of the mix cycle regardless of the current moisture reading, this mode can also be operated without a sensor being connected.

Auto Mode

An amount of water defined by the recipe is added during the pre-wet phase (if required) and the sensor moisture reading is used to control the water addition up to a target defined by the selected recipe during the final-wet phase of the mix.

Calc Mode

An amount of water is added during the pre-wet (if required) and then the system calculates the amount of water to add during the final-wet phase from a 'Calculated Moisture Target' and recipe Dry weight parameter.

NOTE: This mode requires a Calib mode (calibration) cycle to be completed before a Calc Mode cycle can be made. This mode will be disabled if no value of 'Dry weight' has been entered or if there is no water meter present.

Setting Mix Times

Setting the mix times correctly is critical to achieve the best from your Hydro-Control V system. The value of the mix times will vary dependant on the type of mixer, the product to be made and the control mode that is used.

The **First mix time** needs to be sufficiently long to allow the 'dry' aggregates, the cement and any pre-wet (if selected) to mix so that a reasonable reading for the average moisture content can be obtained. Similarly the **Final mix time** needs to be long enough to allow **Final wet** to mix with the aggregates and cement so that a good consistency and reasonable reading for the average moisture content is obtained. Both these times may be established by observing the moisture trend on the Hydro-Control V during a mix cycle. Sufficient mixing has occurred when the moisture trend shows reasonable stability (i.e. a flat line) before the **Final wet** and **MIX COMPLETE** phases are reached respectively.

During the mix phases of a **Calc** or **Calib** mode cycle the system averages the moisture values over the last **Averaging time** seconds (defined by the system parameter **Averaging time** - see section **Edit Control Parameters**) of the mix time.

Therefore, in **Calc** or **Calib** mode, during the **First mix** and **Final mix** phases the system will mix for *at least* the amount of time defined by the **Averaging time**, e.g. if the **First mix time** parameter is set to 10 seconds and the **Averaging time** is set to 20 seconds the first mix will last for 20 seconds, however, if the **First mix time** is set to 25 seconds and the **Averaging time** is set to 20 seconds the first mix will last for 25 seconds.

As it is critical that reasonable stability has been reached before averaging starts it is recommended that the *First mix time* and the *Wet mix time* parameters be set to be at least twice as long as the *Averaging time*.

Mix Time Guidelines

Mixer Type	Control Mode	Averaging Time (s)	First Mix Time (s)	Wet Mix Time (s)
Single Star Planetary	Auto	N/A	30	50
	Calc	20	50	50
Two Star Planetary	Auto	N/A	15	20
	Calc	15	40	40
Twin Shaft	Auto	N/A	15	20
	Calc	15	40	40
Ribbon	Auto	N/A	30	60
	Calc	20	50	60
Turbo	Auto	N/A	20	30
	Calc	15	40	50

Mix times for **Pre-set** mode should be the same as for the intended **Control Mode**



The above is intended only as a guide for getting started. Actual mixing times will vary, and should be optimised for each application.

Further notes are given in sections describing each **Control Mode**.

Editing Recipes

A few seconds after switching the Hydro-Control V on the **Start Menu** screen will appear (– see section **Start Menu**). From this menu, to select or edit a recipe press **<Recipe>** (F2). For full details see sections **Select recipe** and **Edit recipe**.

Up to 99 recipes are available. The number of recipes displayed is selectable (see section 'Edit System Parameters'. Initially all the parameters of the recipes will be set to their default values (see section **Edit recipe parameters**).

To select a recipe from the list use  and  to move the cursor to the required recipe or type the number of the required recipe.

To edit the recipe press **<Edit>** (F4).

Select the parameters to be changed by using the  and  keys, and then typing in the desired value.

Enter the digits, ignoring the decimal point – although with preceding zero if necessary. Alternatively, values can be increased or decreased by using the **<Inc>** (F1) and **<Dec>** (F2) keys - these are also used for non-numerical items which cycle through the valid entries in turn.

After completion of editing press **<Back>** (F5) and then either of the following keys:



to save the changed values and return to the Recipe Menu.



to cancel and return to the Recipe Menu. Choosing this option will return any edited parameters to their original values.

Scrolling down to the 'More...' statement at the bottom of the list will display the second page of the Edit Recipe Screen.

Mix control modes

The control mode of each recipe can be selected using the **Method** parameter in the recipe.

Alternatively, the control mode of the current recipe may be changed from the **Start Menu** by pressing **<Mode>** (F3). The Hydro-Control V will cycle through the control modes available with successive presses of **<Mode>** (F3).

NOTE: Until the recipe's **Dry Weight** parameter has been defined for the recipe the only control modes available will be **Pre-set** and **Auto**. Once a dry weight is defined, the **Calib** mode will be available and after a calibration cycle has been completed the **Calc** mode will also become available.

Preset Mode

This is the basic operating mode, which simply adds preset amounts of water in both the **Pre-wet** and the **Final-wet** phases of the mix cycle.

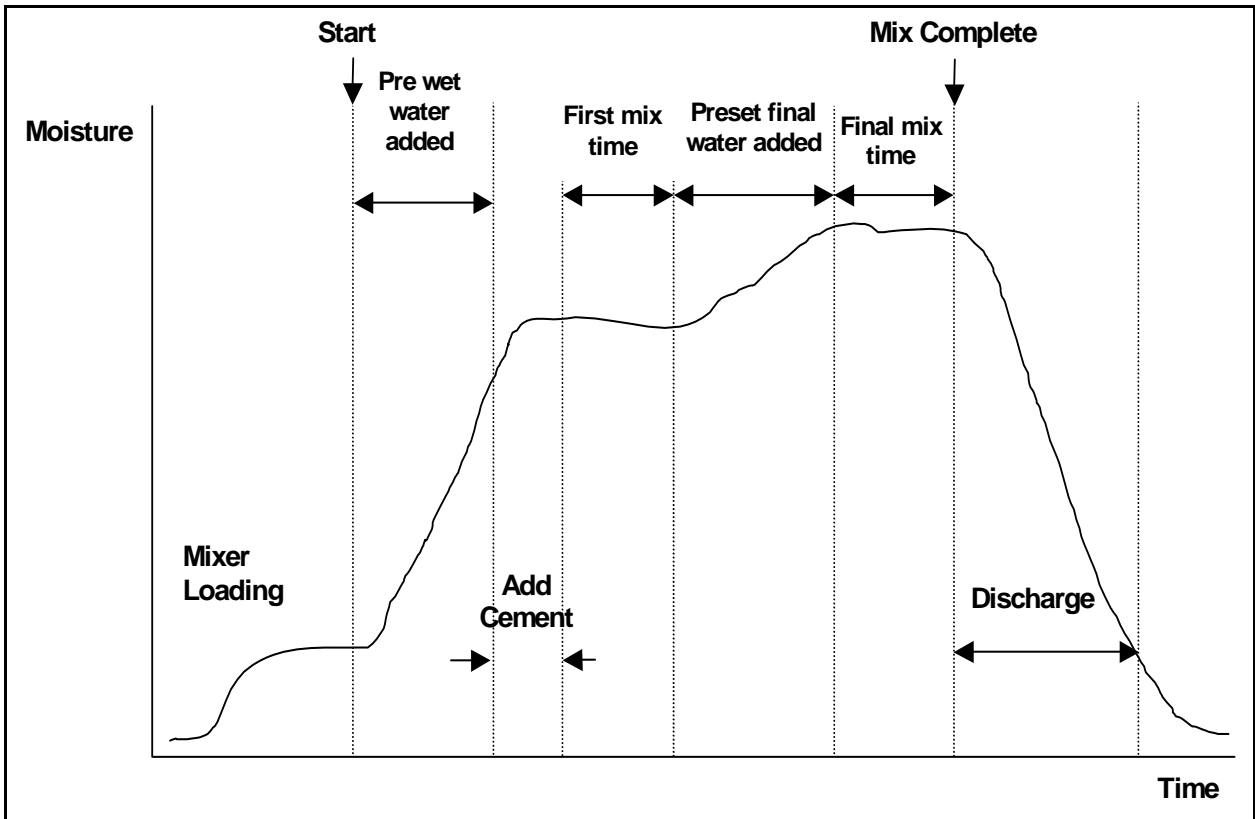



Figure 4 – Preset Mode Mix Cycle

1. From the **Start Menu** press **<Recipe>** (F2)
2. Select the desired recipe number
3. Enter the amount of pre-wet water required in **Pre-wet water** parameter. If you do not require any pre-wet set the **Pre-wet water** and **Pre-wet target** parameters to zero.
4. Enter the amount of final (main) water required in **Preset Final** parameter.
5. Check that the **First mix time** and **Final mix time** parameters are correct.
6. Check the **Water limit** parameter on page two of the recipe is correct
7. Press **<Back>** (F5) and then  to save the changed values and return to the Recipe Menu.
8. Press **<Back>** (F5) to return to the **Start menu**
9. Press **<Mode>** (F3) until **Preset** is displayed under the Recipe number
10. Start the mix cycle from the batch controller or manually by pressing **Start <F1>**

The mix cycle may be paused at any phase of the mix cycle by pressing **<Pause>** (F2).

The following options will be available:

- <Resume>** (F1) Continues the cycle from the point where it was paused.
- <Abort>** (F2) Allows the current mix to be aborted. When pressed the option to generate **MIX COMPLETE** signal is prompted with the following “**Mix Complete Required?**”, **<Yes>** (F2) and **<No>** (F3). If ‘No’ is selected it will return to the **Start Menu**. If ‘Yes’ is selected the mix complete signal is generated and **<Reset>** (F2) returns to the **Start Menu** and clears the **MIX COMPLETE** signal.
- <Trim>** (F3) Opens the **Fine Water** valve all the time the key is depressed, allowing manual adjustment of the moisture level.
- <Update>** (F5) Followed by  saves the adjusted water amounts and moisture level to the current recipe.
- Pressing **<Update>** (F5) during **Pre-wet** or **First mix time** phases of the mix cycle updates the **Pre-wet water** and **Pre-wet target** parameters.
- Pressing **<Update>** (F5) during **Final wet** or **Final mix time** phases of the mix cycle updates the **Preset Final** and the **Target moisture** parameters.

At the end of the **Final mix time** a **MIX COMPLETE** signal is generated indicating to the batch control system that the mixer is ready for discharging. If discharge is set to manual and an automatic **Reset** is not received then the following options will be displayed:

- <Reset>** (F2) Returns the unit to standby and clears the **MIX COMPLETE** signal.
- <Trim>** (F3) Opens the Fine Water valve all the time the key is depressed, allowing manual adjustment of the moisture level.
- <Update>** (F5) Followed by  saves the adjusted water amounts and moisture levels to the current recipe. **Preset Final** and **Target moisture** parameters are updated.

Auto Mode

Auto mode uses an algorithm to progressively add water to the mixer until the **Moisture target** is achieved. As the control only relies on the **Current moisture** value and a **Moisture target** value no calibration is required and a relatively short **First mix time** can be used. Sufficient **Final mix time** should be allowed to let the mix become homogeneous and the moisture stabilise before discharge. A preset amount of water may also be added in the pre-wet phase of the mix cycle if required.

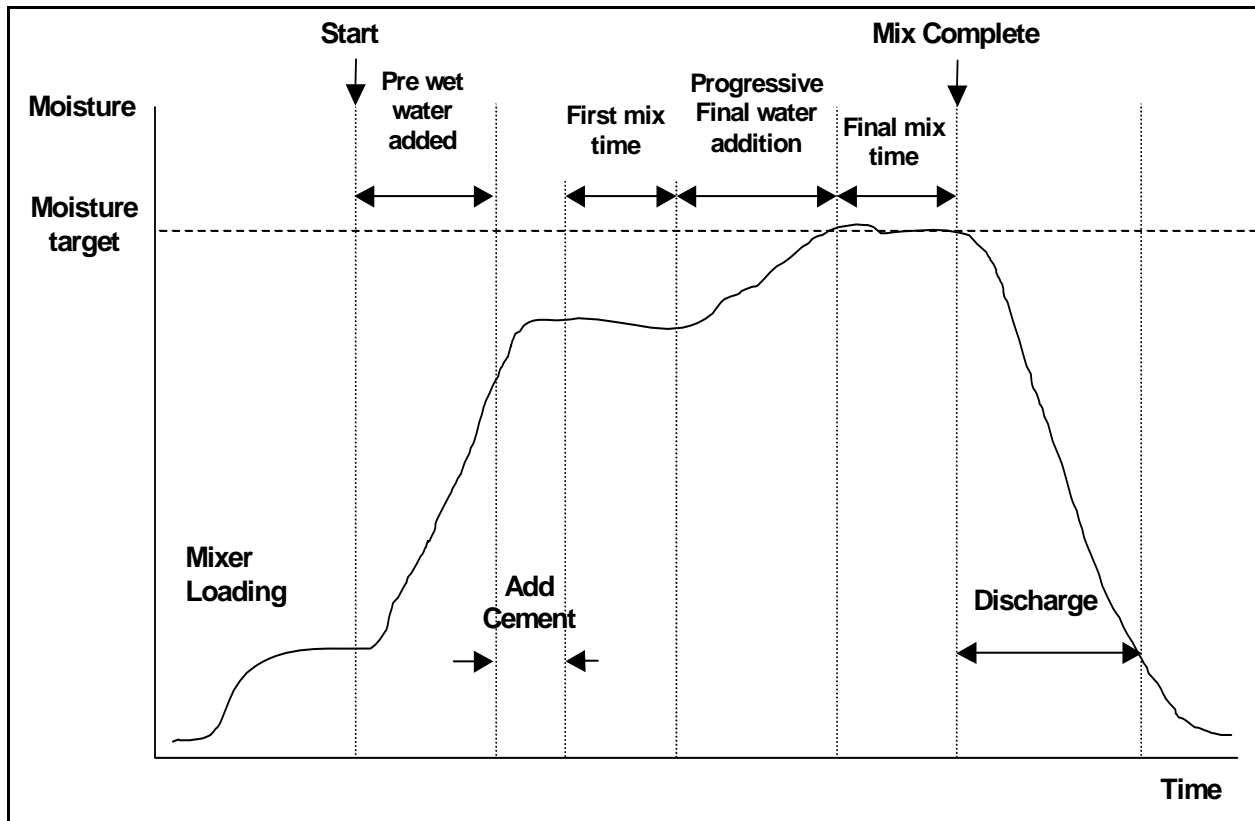



Figure 5 – Auto Mode Mix Cycle

It is usual to run the mix cycle in **Preset** mode for several cycles, switching to **Auto** mode to establish mixing time, water quantities and to ensure that good mix-to-mix moisture consistency is achieved. The mix-to-mix consistency can be checked by pressing **<More...>** (F5) and then **<Log>** (F2) where **Final %** values can be inspected.

It is suggested that the 'discharge' is set to manual mode during **Auto** mode setup to prevent automatic discharge; this enables manual correction to the mix after **MIX COMPLETE**

When running a recipe for the first time in **Auto** mode the system needs to 'learn' the target parameters required with a 'good mix'.

1. From the **Start Menu** press **<Recipe>** (F2)
2. Select the desired recipe number
3. Enter the amount of pre-wet water required in **Pre-wet water** parameter. If you do not require any pre-wet set the **Pre-wet water** and **Pre-wet target** parameters to zero.
4. Enter the amount of final (main) water required in **Preset Final** parameter, if you are unsure, enter a value lower than that required. A manual adjustment to a 'good mix' can be performed during the mix cycle.
5. Check that the **First mix time** and **Final mix time** parameters are correct.
6. Check the **Water limit** parameter on page two of the recipe is correct
7. Press **<Back>** (F5) and then  to save the changed values and return to the **Select Recipe** menu.
8. Press **<Back>** (F5) to return to the **Start menu**
9. Press **<Mode>** (F3) until **Preset** is displayed under the Recipe number
10. Start the mix cycle from the batch controller or manually by pressing **Start <F1>**
11. *As soon as **WET-MIX** begins to flash, press **<Pause>** (F2).*
12. Observe the mix consistency or the quantity of water added and manually add water using **<Trim>** (F3) until the desired amount of water for the **Final-wet** phase has been added.
If a water meter is fitted the quantity of water added will be displayed under the tap icons.
13. When the correct amount of water has been added press **<Update>** (F4).
14. Press  to confirm the update.
15. Press **<Resume>** (F1) to continue with the mix cycle.
16. At the end of the **Final mix time** a **MIX COMPLETE** signal is issued. After the mixer is discharged press **<Reset>** (F2) to return to the **Start Menu**
17. Press **<Mode>** (F3) until **Auto** is displayed under the recipe number. The recipe is now ready to run in **Auto** mode.

The mix cycle may be paused at any phase of the mix cycle by pressing **<Pause>** (F2).

The following options will be available:

- <Resume>** (F1) Continues the cycle from the point where it was paused.
- <Abort>** (F2) Allows the current mix to be aborted. When pressed the option to generate **MIX COMPLETE** signal is prompted with the following “**Mix Complete Required?**”, **<Yes>** (F2) and **<No>** (F3). If ‘No’ is selected it will return to the **Start Menu**. If ‘Yes’ is selected the mix complete signal is generated and **<Reset>** (F2) returns to the **Start Menu** and clears the **MIX COMPLETE** signal.
- <Trim>** (F3) Opens the **FINE WATER** valve all the time the key is depressed, allowing manual adjustment of the moisture level.
- <Update>** (F5) Followed by  saves the adjusted water amounts and moisture levels to the current recipe.
- Pressing **<Update>** (F5) during **Pre-wet** or **First mix time** phases of the mix cycle updates the **Pre-wet water** and **Pre-wet target** parameters.
- Pressing **<Update>** (F5) during **Final wet** or **Final mix time** phases of the mix cycle updates the **Preset Final** and the **Target moisture** parameters.

At the end of the **Final mix time** a **MIX COMPLETE** signal is generated, indicating to the batch control system that the mixer is ready for discharging. If discharge is set to manual and an automatic **Reset** is not received then the following options will be displayed:

- <Reset>** (F2) Returns the unit to standby and clears the **MIX COMPLETE** signal.
- <Trim>** (F3) Opens the **FINE WATER** valve all the time the key is depressed, allowing manual adjustment of the moisture level.
- <Update>** (F5) Followed by  saves the adjusted water amounts and moisture levels to the current recipe. **Preset Final** and **Target moisture** parameters are updated.

Auto Mode Control Parameters

The progressive algorithm used by **Auto** mode controls the effective water flow into the mixer. The water flow rate is controlled by pulsing the water valves on and off. As the moisture level approaches the moisture target the amount of 'on' time compared to the amount of 'off' time is reduced, which reduces the average flow rate.

From the **Start Menu**, pressing **<More...>** (F5), followed by **<Setup>** (F1) gives access to the system configuration menus. It is necessary to enter the Advanced Password (see Appendix D) to access the Control Parameters, after the password has been entered press **<Control>** (F3).

The following parameters are used to control the progressive water addition: -

Gain: Controls how fast water is put into the mixer. A higher value will increase the rate at which water enters the mixer. It is normal to start with a value of 20. Observe the trend line during a mix cycle to determine if the water is entering the mixer at the desired rate. Increase the value (initially by 5) to increase the water flow rate, reduce the value to reduce the water flow rate. A value of 20-40 is typical for moderate to good mixers with correctly sized water valves. Slower acting mixers will use lower values.

Upper Control Threshold: Controls the point when the water valves change from 'always on' to 'pulsing'. A lower value will keep the valves in the 'always on' state for longer, only allowing the valves to 'pulse' on and off closer to the **Moisture target**. Values of 50 or 70 are typical for most applications if the **Gain** is set correctly.

Lower Control Threshold: Determines the minimum flow rate that can be used by the progressive algorithm. This parameter is used to prevent the water flow being too slow when the actual moisture is very close to the **Moisture Target**. Typical values will be between 10 and 25. A higher value increases the minimum water flow near the **Moisture Target**.

Valve on/off Time: Determines how *quickly* the valve can be switched on and then immediately off again. This parameter should be set as fast as practically possible for a pulse of water to be delivered. Once set this parameter should **not** be altered.

Optimising the **Auto** mode control is a balance between the top three parameters. It is suggested that starting from default values, the parameters are altered in the following sequence:

1. Set the **Gain** parameter to achieve reasonable flow at the beginning of the **Final wet** phase
2. Increase the **Lower Control Threshold** so that the **Moisture Target** is reached at the maximum possible rate without excessive overshooting.
3. Set the **Upper Control Threshold** to optimise when the valves switch from 'always on' to 'pulsing'

NOTE: Setting up the **Auto** mode control parameters should be performed with a full batch. The **Recipe gain** parameter in the relevant recipe should be set to the batch size if a smaller batch is to be made.

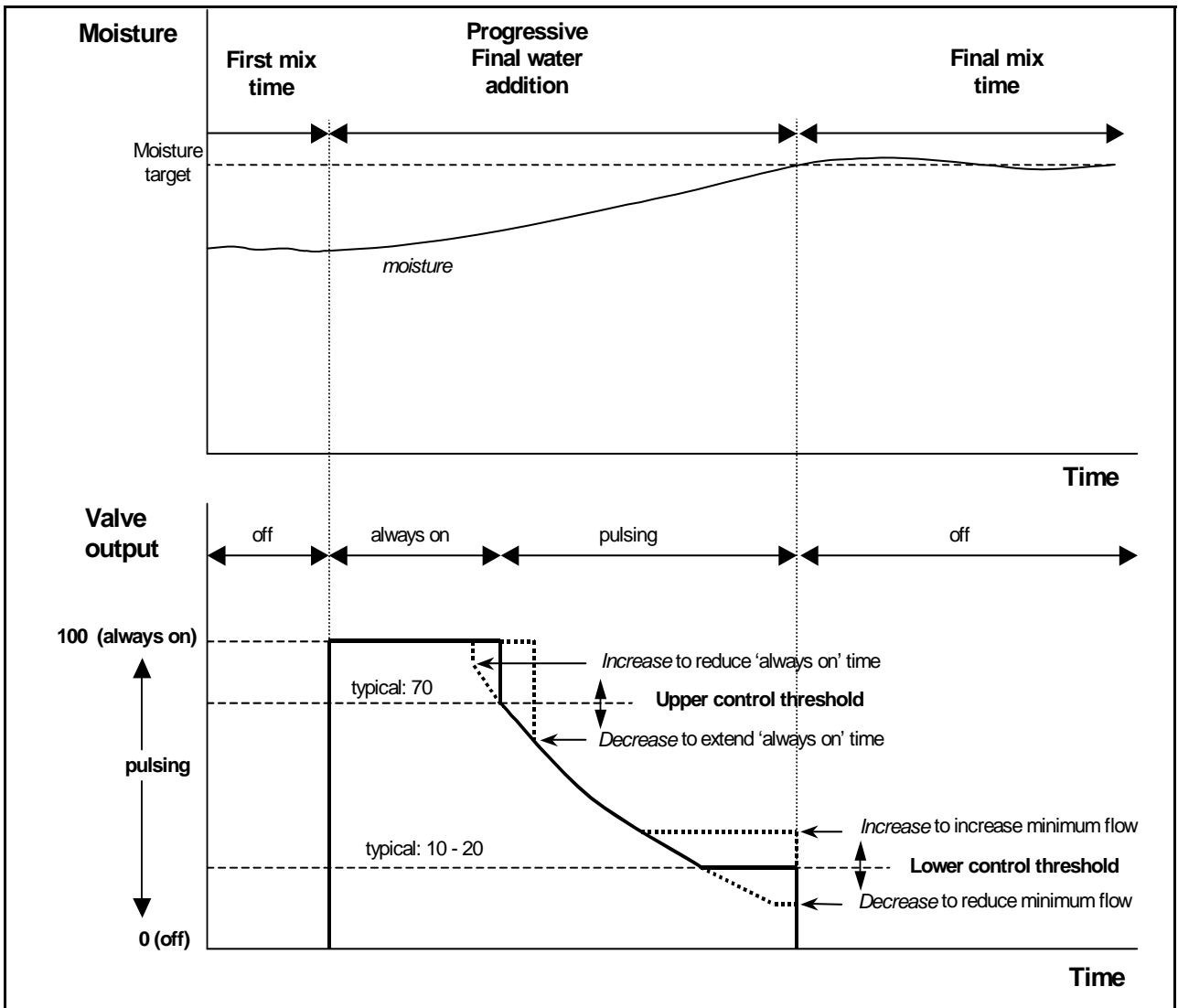

Figure 6 – Valve Control in Auto Mode

Calc mode

Calc mode uses the **Dry weight** parameter from the recipe and a **Calculation target** to calculate the amount of water required to achieve the **Target moisture**. To achieve a correct calculation, each recipe using **Calc** mode must be calibrated. The 'dry reading' used for the calculation must be very accurate and this usually requires the **First mix time** to be longer than is necessary for **Auto** mode control. To achieve a very accurate 'dry reading' the moisture signal is averaged for a time defined by the system parameter **Averaging time**. It is critical that the moisture signal is stable before this averaging time starts in order to obtain a correct value.

The advantage of **Calc** mode is that the water is added in 'one shot', which usually makes the **Final wet** phase quicker than would be the case with progressive water addition. **Fine Delivery** determines the amount of water to be added with the fine valve only, so that the calculated value of water is delivered accurately and without causing excessive overshoot.

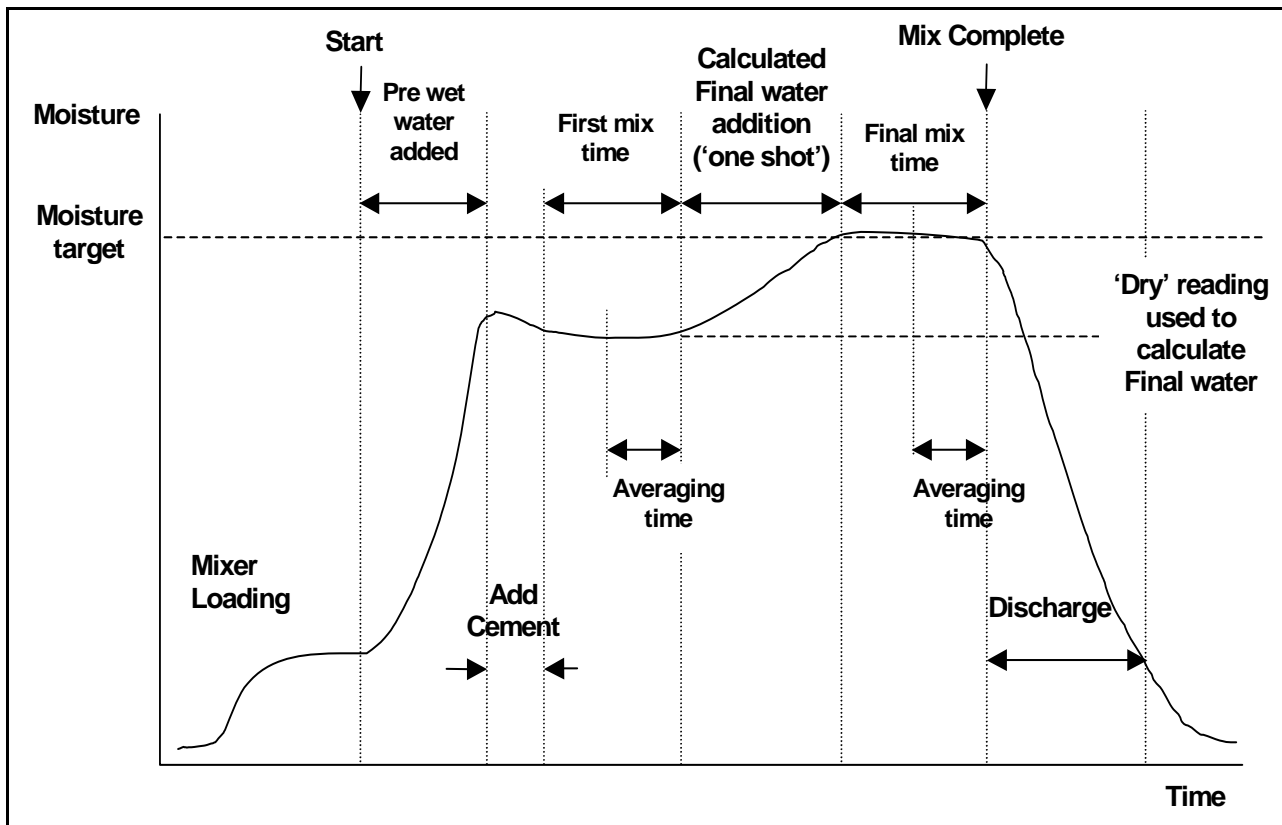

Figure 7 – Calc Mode Mix Cycle

Calibrating a Recipe

In order to run a recipe in **Calc** mode the recipe needs to be calibrated.



It is usual to run the mix cycle in **Preset** mode for several cycles before performing a calibration to establish mixing time, water quantities and to ensure that good mix-to-mix moisture consistency is achieved. The mix-to-mix consistency can be checked by pressing **<More...>** (F5) and then **<Log>** (F2) where **Final %** values can be inspected.



It is suggested that the 'discharge' is set to manual mode during calibration to prevent automatic discharge; this enables manual correction to the mix after **MIX COMPLETE**.

A calibration run can be carried out in two ways depending on whether any 'admix' is required.

Calibration without admix

When calibrating without admix, or when the admix is added during the **First mix time**, there is usually one water addition phase and the mix cycle will complete with one final-wet and one wet-mix phase. The final mix time used during a calibration cycle is extended by the Mix extension time to ensure that a good final reading is obtained.



1. From the **Start Menu** press **<Recipe>** (F2)
2. Select the desired recipe number
3. Enter the amount of pre-wet water required in **Pre-wet water** parameter. If you do not require any pre-wet, set the **Pre-wet water** and **Pre-wet target** parameters to zero.
4. Enter the amount of final (main) water required in **Preset Final** parameter, if you are unsure, enter a value lower than that required. A manual adjustment to a 'good mix' can be performed at the end of the mix cycle, so ensure that the discharge is set to manual.
5. Check that the **First mix time** and **Final mix time** parameters are correct.
6. Set the **Dry weight** parameter on page two of the recipe to that of your mix.
7. Check the **Water limit** parameter on page two of the recipe is correct
8. Press **<Back>** (F5) and then  to save the changed values and return to the Recipe Menu.
9. Press **<Back>** (F5) to return to the **Start menu**
10. Press **<Mode>** (F3) until **Calib** is displayed under the Recipe number
11. Start the mix cycle from the batch controller or manually by pressing **<Start>** (F1)
12. On starting the mix an edit box appears which shows the current calibration water (this will be the amount entered in the parameter **Preset Final Water**. Type in the amount of water required if this is different and then press  to accept.
13. At the end of the **Final mix time** a **MIX COMPLETE** signal is issued. An edit box will appear which shows the final moisture reached for this mix. You may accept this as the **Moisture target** or enter a new value if appropriate.



NOTE: Entering a new value of moisture only alters the *displayed* moisture figure - the calibration is *not* effected. Then press the accept button .
14. If the discharge is set to manual, then the quantity of water may be manually adjusted by pressing **<Trim>** (F3). The quantity of water added will be displayed under the tap icons.
15. When the correct amount of water has been added press **<Update>** (F4), followed by 
16. Discharge the mixer and press **<Reset>** (F2) to return to the **Start menu**

The recipe is now calibrated and **Calc** will be displayed under the recipe number indicating that the next mix cycle will be performed in **Calc** mode.

Calibration with admix (2-stage calibration mix cycle)

When calibrating with admix there are two water addition phases and the mix cycle will complete with two final-wet and two wet-mix phases. The **Busy** signal from the Hydro-Control V will activate during the second water addition to add the admix. In order for the **Busy** signal to operate correctly the **Busy mode** parameter must be set to **Admix** (see section Setup System).

1. From the **Start Menu** press **<Recipe>** (F2)
2. Selected the desired recipe number
3. From the recipe menu press **<Edit>** (F4)
4. Scroll to the bottom of the recipe menu to the parameter **Calibration Type** and select **2 point**
5. Enter the amount of pre-wet water required in **Pre-wet water** parameter. If you do not require any pre-wet set the **Pre-wet water** and **Pre-wet target** parameters to zero.
6. Enter the amount of final (main) water required in **Preset Final** parameter, if you are unsure, enter a value lower than that required. A manual adjustment to a 'good mix' can be performed at the end of the mix cycle, so ensure that the discharge is set to manual.
7. Check that the **First mix time** and **Final mix time** parameters are correct.
8. Set the **Dry weight** parameter on page two of the recipe to that of your mix.
9. Check the **Water limit** parameter on page two of the recipe is correct
10. Press **<Back>** (F5) and then  to save the changed values and return to the Recipe Menu.
11. Press **<Back>** (F5) to return to the **Start menu**
12. Press **<Mode>** (F3) until **Calib** is displayed under the Recipe number
13. Start the mix cycle from the batch controller or manually by pressing **<Start>** (F1)
14. On starting the mix an edit box appears which shows the current calibration water (this will be the amount entered in the parameter **Calib Water** in the first and the **Preset Final – Calib Water** in the second (if this is greater than zero). Type in the amount of water required if this is different and then press  to accept the first and  to accept the second value.
15. At the end of the **Final mix time** a **MIX COMPLETE** signal is issued. An edit box will appear which shows the final moisture reached for this mix. You may accept this as the **Moisture target** or enter a new value if appropriate.

NOTE: Entering a new value of moisture only alters the *displayed* moisture figure - the calibration is *not* effected. Then press the accept button .
16. If the discharge is set to manual, then the quantity of water may be manually adjusted by pressing **<Trim>** (F3). The quantity of water added will be displayed under the tap icons.
17. When the correct amount of water has been added press **<Update>**(F4), followed by 
18. Discharge the mixer and press **<Reset>** (F2) to return to the **Start menu**

The recipe is now calibrated and **Calc** will be displayed under the recipe number indicating that the next mix cycle will be performed in **Calc** mode

A **Calib** mode mix cycle may be paused at any phase of the mix cycle by pressing **<Pause>** (F2).

The following options will be available:

- <Resume>** (F1) Continues the cycle from the point where it was paused.
- <Abort>** (F2) Allows the current mix to be aborted. When pressed the option to generate **MIX COMPLETE** signal is prompted with the following “**Mix Complete Required?**”, **<Yes>** (F2) and **<No>** (F3). If ‘No’ is selected it will return to the **Start Menu**. If ‘Yes’ is selected the mix complete signal is generated and **<Reset>** (F2) returns to the **Start Menu** and clears the **MIX COMPLETE** signal.

At the end of the **Final mix time** a **MIX COMPLETE** signal is generated indicating to the batch control system that the mixer is ready for discharging. If discharge is set to manual and an automatic **Reset** is not received then the following options will be displayed:

- <Reset>** (F2) Returns the unit to standby and clears the **MIX COMPLETE** signal.
- <Trim>** (F3) Opens the Fine Water valve all the time the key is depressed, allowing manual trimming of the moisture level.
- <Update>** (F5) Followed by  saves the adjusted water amounts and moisture levels to the current recipe. **Preset Final** and **Target moisture** parameters are updated.

A **Calc** mode mix cycle may be paused at any phase of the mix cycle by pressing **<Pause>** (F2).

The following options will be available:

- <Resume>** (F1) Continues the cycle from the point where it was paused.
- <Abort>** (F2) Allows the current mix to be aborted. When pressed the option to generate **MIX COMPLETE** signal is prompted with the following “**Mix Complete Required?**”, **<Yes>** (F2) and **<No>** (F3). If ‘No’ is selected it will return to the **Start Menu**. If ‘Yes’ is selected the mix complete signal is generated and **<Reset>** (F2) returns to the **Start Menu** and clears the **MIX COMPLETE** signal.

At the end of the **Final mix time** a **MIX COMPLETE** signal is generated indicating to the batch control system that the mixer is ready for discharging. If discharge is set to manual and an automatic **Reset** is not received then the following options will be displayed:

- <Reset>** (F2) Returns the unit to standby and clears the **MIX COMPLETE** signal.

NOTE: **<Update>** is not available in **Calc** mode; any adjustment should be performed using the **Water trim** parameter.

Water trim parameter (Calc mode only)

When **Calc** mode is the current the control mode **<Trim>** (F4) will be displayed in the **Start Menu**.

When **<Trim>** (F4) is pressed an edit box appears allowing an amount of water to be *added* or *removed* from *all* subsequent **Calc** mode mix cycles for the current recipe.

The numeric keys and **<Inc>** (F1), **<Dec>** (F2) and **<+/->** (F3) may be used to set the value of adjusted water. Alternatively the **Water trim** parameter can be edited using the **Edit recipe** menu.

NOTE: The **Minus tolerance** moisture alarm will be disabled if a negative adjustment is entered to prevent nuisance alarms.

'Pre-Wet' mix cycle

The Hydro-Control V can operate in one of two **Pre-wet** mix cycle modes:

Pre-set mode (Pre):

The quantity of water defined by **Pre-Wet** water is added, regardless of measured moisture.

The speed and accuracy of the **Pre-wet** water addition will be determined by the valves and the **In-flight** and **Fine delivery** settings in the **Edit Control** menu.

Auto mode (Auto):

The sensor moisture reading is used to add water up to the **Pre-wet target** using **Auto mode** control. **Pre-wet** water is added using the same control algorithm and control parameters as used for **Auto mode Final wet**.

Auto mode control parameters that are optimised for final water addition where accuracy is required may produce a slower than desirable **Pre-wet** where accuracy is not normally as important. In the case where an **Auto mode Pre-wet** is followed by a **Calc mode Final wet** the **Recipe gain** can be increased to improve the speed of the **Pre-wet** water addition.

Temperature Compensation

Temperature compensation can be used to correct for changes in ambient temperatures throughout the year and adjust the final moisture target to maintain mix consistencies. Two recipe parameters are used for temperature compensation:

Temperature : The is the base temperature from which the compensation will be calculated.
The temperature is measured by the sensor and displayed on the front page (see Figure 9).
At the time of setting up the recipe this value should be read from the front screen and the reading used in the recipe as the base temperature. **This value should not be adjusted following this reading.**

Temp. Coeff : The temperature coefficient is the compensation factor in %moisture / Temperature (i.e.: how far the moisture target is anticipated to change per degree change in temperature)

From these two parameters the Moisture Target is then calculated by the following:

$$\text{Corrected Moisture Target} = (\text{Moisture target}) + (\text{Temperature Difference} * \text{Temp. Coeff})$$

Correction is applied for '**Calc**' or '**Auto**' mixes only, there is no compensation during a **Calib** mix or if a **Pre-set** amount of water is added.

Example:

Final Moisture	6.5	%
Temperature	20	°C
Temp. Coeff.	0.100	%moisture/°C

If the current temperature measured is 25.0 °C then the moisture target will become 7.0%.
If the current temperature measured is 15.0 °C then the moisture target will become 6.0%.

Menu Tree

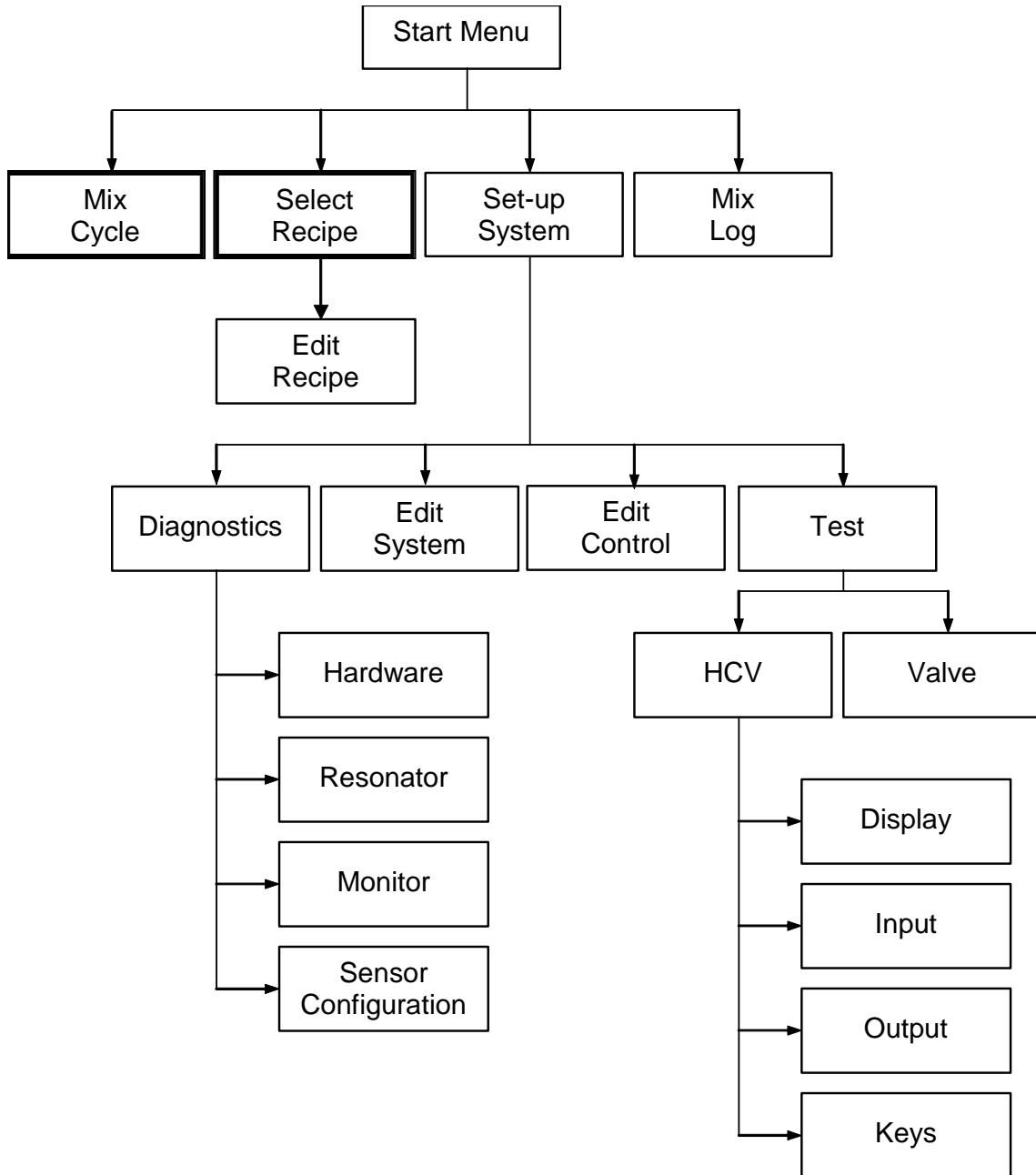

Figure 8 – Menu Tree

In routine operation the user can operate the system using only the two highlighted menus shown above ('Mix Cycle' & 'Select Recipe'). However additional 'Set up' and 'Diagnostic' menus are provided to permit flexibility and complete control.

Start Menu

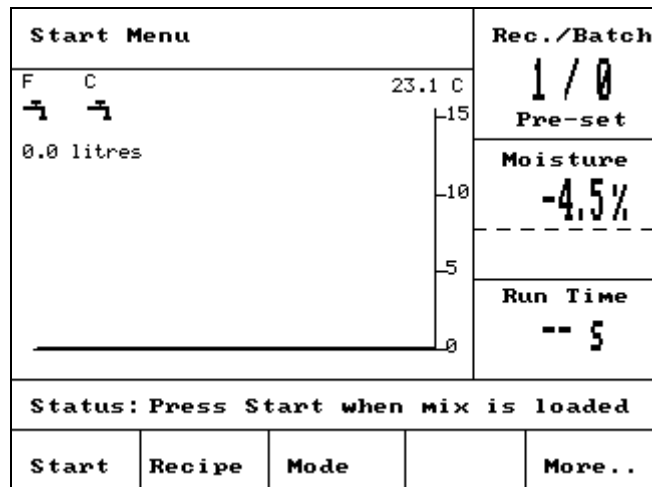





Figure 9 – Start Menu

After switching on the system a message stating

Rom OK
perform Ram test?

is displayed for 5 seconds. Pressing  will start the RAM test, which takes approximately 60 seconds.

After the Ram test completes or 5 seconds has passed, the Hydronix logo and firmware version is shown and is then replaced by the **Start menu** and 'trend' moisture graph.

- The 'trend' display is a scrolling moisture level graph, which also shows the 'Target' (T) and 'Alarm' (A) levels for the chosen Recipe if in 'Auto' or 'Calculation' modes.
- 'Tap' icons, which show the Status (Off  or On ) of the **FINE WATER** and **COARSE WATER** valves. Underneath the valves are number(s) showing how much water has been delivered. If a water meter is used the total number of litres or gallons is shown. If no water meter is used, beneath each valve is the time that valve has been open, in units of 0.1 seconds.
- Recipe number, batch number and control method (top right of display).
- Moisture readings and targets (centre right of display). Large number shows current moisture, smaller numbers underneath show:
 - The amount of water to be added during the current phase of the mix cycle
 - Moisture target of the current recipe
 - Trim water of the current recipe (only in **Calc** mode)
- The temperature of the mixture (in degrees Centigrade or Fahrenheit) is also shown at the top right of the display, just above the moisture axis of the trend graph.

<Start> (F1) Manually starts the mix cycle

<Recipe> (F2) Displays the **Select Recipe** menu where recipes may be selected and edited.

<Mode> (F3) Change the control mode of the current recipe.
Note: until a **Dry weight** has been defined for the recipe the only control modes available will be **Auto** and **Pre-set**. Once a **Dry weight** is defined the **Calib** mode will be available. After a **Calib** mode mix cycle has been carried out the **Calc** mode will also become available.

<More...> (F5) Displays further options as follows: -

<Setup> (F1) Displays the **Setup System** menu (see section **Setup System**).

<Log> (F2) Displays the **Mix log** (see section **Mix log**).

<Back> (F5) Returns to the main menu with **<Start>** (F1), **<Recipe>** (F2), **<Mode>** (F3) and **<More...>** (F5) present

Water trim parameter (Calc mode only)

When **Calc** mode is the current the control mode **<Trim>** (F4) will also be displayed below the moisture reading on the main page.

<Trim> (F4) An edit box allows trim water to be *added or removed* from *all* subsequent calculation runs for the current recipe.
The numeric keys and **<Inc>** (F1), **<Dec>** (F2) and **<+/->** (F3) may be used to set the value of trim water.

Alternatively the trim parameter can be edited using the **Edit recipe menu**.

Select Recipe

From the **Start Menu**, pressing F2 will enter the **Select Recipe** menu.

Select Recipe					Rec./Batch
No.	Pre Wet	Mix s	Final Wet%	Wet Mix s	1 / 0 Pre-set
>01P	0.0	20	6.5	30	Moisture
02P	0.0	20	6.5	30	---
03P	0.0	20	6.5	30	
04P	0.0	20	6.5	30	
05P	0.0	20	6.5	30	
06P	0.0	20	6.5	30	
07P	0.0	20	6.5	30	
08P	0.0	20	6.5	30	
09P	0.0	20	6.5	30	Run Time
10P	0.0	20	6.5	30	-- 5
Status: Select					
Def s	Copy		Edit	Back	

Figure 10 – Select Recipe

Using the Select Recipe Menu

The system is set up with **99 recipes**. Initially all the parameters of these recipes will be set to their default values (see section **Edit recipe parameters**).

To select a recipe from the list use  and  to move the cursor to the required recipe or type the number of the required recipe

e.g. enter  followed by  for recipe 3
or  followed by  for recipe 64.



- <Def s>** (F1) Set the selected recipe to the values defined by the **Default Recipe** – see section **Edit System Parameters**.
- <Copy>** (F2) Enables copying of recipes
- <Edit>** (F4) Edits the selected recipe.
- <Back>** (F5) Returns to the previous menu.

Edit Recipe

Edit Recipe		Rec./Batch
Pre-wet water -lits : 0.0	<	1 / 0
Pre-wet target : 0.0		Pre-set
Pre-wet mode : Pre		Moisture
Pre-wet delay : 0		---
First mix time : 20		Run Time
Cement timeout : 15		-- 5
Moisture target : 6.5		
Preset final -lits : 0.0		
Final mix time : 30		
More..		
Status:		
Inc	Dec	Back





Figure 11 – Edit Recipe (1st Page)

Using the Edit Recipe Menu



To edit a recipe (see next section for learning a new recipe) select the parameters to be changed by scrolling through the parameter list using the up  and down  keys, and then typing in the desired value.

Enter the digits ignoring the decimal point – although with preceding zero if necessary. Alternatively, values can be increased or decreased by using the <Inc> (F1) and <Dec> (F2) keys - these are also used for non-numerical items which cycle through the valid entries in turn.

Example: To change the **Final mix time** from 15s to 8s:

- Use the  and  keys to move the cursor to the **Final mix time** parameter
- Enter  followed by  on the numeric keypad. The value 08s will be displayed next to the **Final mix time** parameter.

After completion of editing press <Back> (F5) and then either of the following keys:

-  to save the changed values and return to the **Select Recipe** menu.
-  to cancel and return to the **Select Recipe** menu. Choosing this option will return any edited parameters to their original values.

Scrolling down to the '**More...**' statement at the bottom of the list will display the second page of the **Edit Recipe** menu.

Edit Recipe				Rec./Batch
				1 / 0
Control method : Pre <				Pre-set
Plus tolerance % : 1.0				Moisture
Recipe gain : 1.0				
Minus tolerance % : 0.2				---
Dry weight of mix kg: 0				Run Time
Calib. water -lits : 0.0				
Water limit -lits : 120.0				-- 5
Batch counter : 0				
More..				
Status:				
Inc	Dec			Back

Figure 12 – Edit Recipe (2nd Page)

Edit Recipe				Rec./Batch
				1 / 0
Moisture offset : -3.6364				Pre-set
Moisture gain : 0.1817				Moisture
Water trim -lits : 0.0				
Cement weight kg : 0				---
Temperature : 20.0				Run Time
Temp. Coeff. : 0.000				
Calibration Type : 1 Point				-- 5
Status:				
Inc	Dec	+/-		Back

Figure 13 – Edit Recipe (3rd Page)

Parameter	Units	Default	Range
Pre-wet water	Seconds, Litres or US Gals	0.0	0.0 - 999.9
Pre-wet target	%	0.0	0.0 – 99.9
Pre-wet mode	None	Pre	Pre, Auto
Pre-wet delay	Seconds	0	0 -999
First mix time	Seconds	20.0	0 – 999
Cement timeout	Seconds	15.0	0 – 999
Moisture target	% Moisture	6.5	0.0 – 99.9
Preset final	Seconds, Litres or US Gals	0.0	0.0 – 999.9
Final mix time	Seconds	30.0	0 – 999
Control Method	None	Pre	Auto, Pre (Calc - only if calibrated)
Plus tolerance %	% Moisture	1.0%	0.0 – 99.9
Recipe gain	None	10.0	0.0 – 10.0
Minus tolerance	% Moisture	0.2	0.0 – 9.9
Dry weight	Kg or US pounds	0	0 – 99999
Calib. water	Litres or US Gals	0.0	0.0 – 999.9
Water limit	Litres or US Gals	120.0	0.0 – 999.9
Batch counter	None	0	0 – 99
Moisture offset	None	-3.6364	-99.9999 – 99.9999
Moisture gain	None	0.1818	0 – 9.9999
Water trim	Litres or US Gals	0.0	-999.9 – 999.9
Cement weight	Kg or US pounds	0	0 – 99999
Temperature	Degree Celsius or Fahrenheit	20.0	0.0 – 999.9
Temp. Coeff	% Moisture / °Temp.	0.000	0.000 – 9.999
Calibration Type	None	1	1, 2

Pre-wet water The quantity of water to add during the **Pre-wet** phase of the mix cycle if the **Pre-wet mode** is set to **Pre-set mode**.

Pre-wet target: The moisture value to be reached during the **Pre-wet** phase of the mix cycle if the **Pre-wet mode** is set to **Auto mode**

Pre-wet mode: The Hydro-Control V can operate in one of two pre-wet modes:

- **Pre-set mode (Pre):** The quantity of water defined by **Pre-wet water** is added, regardless of measured moisture.
- **Auto mode (Auto):** The sensor moisture reading is used to add water up to the **Pre-wet target** using **Auto mode** control (- see section **Auto mode**)

NOTE: When the main **Control Mode** is set to **Pre-set** or **Calib mode** the Hydro-Control V will use **Pre-set mode** for the **Pre-wet** phase of the mix cycle regardless of the **Pre-wet mode** setting.

Pre-wet delay: The delay between **Pre-wet** phase completing and continuing the mix cycle. Delays the **Pre-wet done** signal, allowing any **Pre-wet** water to be mixed before cement is added.

First mix time: The duration of the mix that follows the addition of any **Pre-wet** water and the cement (see Section **Setting Mix Times**).

Cement timeout: Maximum time system will wait for **CEMENT IN** signal before beginning **First mix time**. If the system exceeds the maximum permitted waiting time for the **CEMENT IN** signal, the system will automatically pause the mix cycle, sound and output **ALARM**. If no **CEMENT IN** signal is to be used after a **Pre-wet** phase set this parameter to zero.

Moisture target: The moisture value to be reached during the final mix phase.

Preset final: The amount of water to be added during the final wet phase of the mix cycle.

Final mix time: The duration of the mix that follows the addition of the final water (see Section **Setting Mix Times**).

Control Mode: The Hydro-Control V can operate in one of three control modes:

- **Preset mode (Pre):** where the entered amount of water is always added, regardless of measured moisture.
- **Auto mode (Auto):** This mode adds a preset amount of water defined by **Preset Water** during the 'Pre-Wet' phase and then uses the sensor moisture readings to control the water addition up to the **Moisture target** (see section 'Auto mode').
- **Calculation mode (Calc):** This mode adds a preset amount of water and then calculates the amount of water to add from a 'Calculated Moisture Target' and the 'Dry Weight' of the mix. This mode will be disabled if no value of 'Dry weight' has been entered or if there is no water meter present. A **Calib** mode mix cycle must be performed in order to calibrate the recipe before this Control mode can be used (– see section **Calc mode**).

Plus tolerance: Moisture % above target % at the end of the **Final mix time** at which the system will sound and output **ALARM**. Disabled after mix complete

Recipe Gain: (*Used only in Auto mode.*) A tuning factor for the control algorithm to provide accurate control for smaller batch sizes. For a normal batch size this will be 1.0. For reduced batch sizes it will be a number between 0.0 and 1.0. The **Recipe Gain** would be set according to the following guidelines:

For example:	¾ Batch	Recipe Gain = 0.75
	½ Batch	Recipe Gain = 0.5
	¼ Batch	Recipe Gain = 0.25

In the case where an **Auto-mode Pre-wet** is followed by a **Calc mode Final Wet** the **Recipe Gain** can be increased up to a maximum value of 10.0 to improve the speed of the **Pre-wet** water addition.

Minus tolerance: Moisture % below target % at the end of the **Final mix time** at which the system will sound and output **ALARM**. In **Auto** mode if the moisture % falls below this tolerance during the **Final mix time** the cycle will revert to **Final wet** and attempt to reach the **Moisture target**. Disabled after mix complete

Dry weight: The total dry weight of the mix including all sand, aggregates and cement.

Calib. water: The **Preset final** parameter defines the amount of water to be added during the final wet phase of a calibration mix cycle. Setting the **Calib. water** value to be less than the **Preset Final** allows the water to be added in two phases. During the first phase of water addition (when **Calib. water** litres are added) the calibration slope will be calculated and during the second phase of water addition (when **Preset final** minus **Calib. water** litres are added) the admix is also added. The **Moisture target** is then defined with any required admix present but the calibration slope is not effected.

Water limit: The maximum amount of water that would ever need to be added for this recipe.

Batch counter: A batch number to identify a mix in the mix log.

Default recipe values may be edited under **Setup System** - see section **Edit System Parameters**.

Moisture offset and gain: Factors to convert sensor units into moisture units. These parameters are used to convert the sensor's unscaled reading into a displayed moisture value. The conversion performed is:

$$\text{Displayed Moisture} = (\text{Unscaled} \times \text{Moisture gain}) + \text{Moisture offset}$$

With default values the displayed moisture is not intended to be a true indication of the actual value. It is possible to display actual moisture values by using the results of a 'bake out' test to calculate correct **Moisture offset** and **Moisture gain** values.

Since **Auto** mode and **Calc** mode use the **Moisture gain** parameter in calculations changing these parameters will affect the control. As a result, it may be necessary to recalibrate recipes or change control parameter.

Typical values will be 0 to -5 for offset & 0.1200 to 3.0000 for the gain. If the parameters are changed, all other moisture parameters in the recipe will be automatically re-scaled.

Water trim: An amount of water added or removed from the final water of a **Calc** mode mix cycle.



Cement weight: The weight of cement in the mix. This parameter is only used for calculating the water/cement ratio which is displayed in the **Mix log**.

Temperature : The base temperature used for temperature compensation in either degrees Centigrade (Metric Mode) or degrees Fahrenheit (US Mode).

Temp. Coeff.: The compensation factor used for temperature compensation in % moisture per degrees temperature (°C or °F). If no compensation is required this should be set to 0.000.

Calibration Type: Determines whether the calibration will be a 1-point or 2-point calibration mix cycle (when calibrating with admix), refer to page 23/24 for more information.

Copy Recipe

From the edit recipe page, it is possible to copy complete parameters from one recipe to another. Pressing <F2> will display the copy recipe page as shown below. Enter the recipe number to be copied in the 'From' section using the numeric keypad and press . Then enter the destination recipe number in the 'To' section and press .

Select Recipe		Rec./Batch
<div style="border: 1px solid black; padding: 5px; text-align: center;"><p>Copy</p><p>From : 1</p><p>To : 2</p> <p>X to cancel</p><p>✓ to accept</p></div>		4 / 17
		Calc
		Moisture
		---.---
		Run Time
		-- 5
Status: Select		

Figure 14 – Copy Recipe page

Mixing

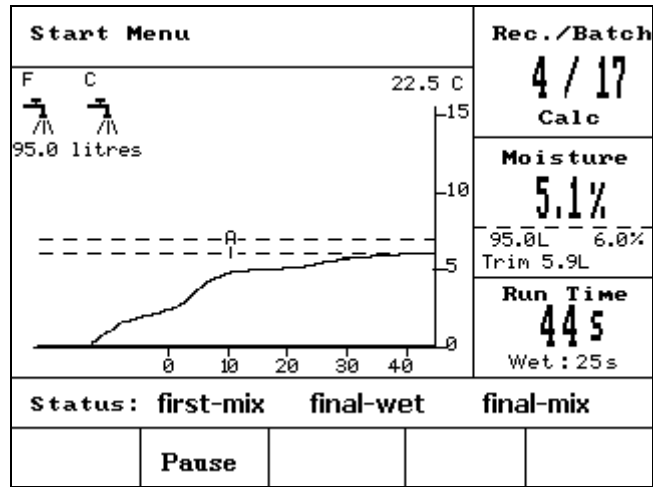

Figure 15 – Mix Cycle

Mix cycle

The current recipe number is displayed in the top box on the right of the screen along with the recipe control method and the batch number.

The mix run time is displayed in the bottom box on the right of the screen and along the bottom of the trend graph. Also shown under the run time is a count down of the remaining time in mixing phases of the cycle (first mix-time or final mix-time).

Throughout the cycle the current moisture value is displayed both in the middle box on the right of the screen and on the trend graph. Towards the end of the first mix and the final mix times the large % sign flashes. This is because the sensor is within its averaging time and at this point the moisture trace should be stable.

The middle box on the right of the screen also displays the amount of water to be added during the current phase of the mix cycle and the moisture target.

The mix cycle phases are displayed in the status bar with the name of each phase of the cycle flashing between CAPITALS and lowercase to indicate the phase of the cycle reached.

NOTE: If no pre-wet is required the **Pre-wet water** recipe parameter should be set to zero. This will ensure that a 'dry mix cycle' will be used.

The cycle can be paused at any point by pressing **<Pause>** (- see section Trim and Update).

System automatic pause and alarm

Cement timeout

If the system exceeds the maximum permitted waiting time for the **CEMENT IN** signal, the system will sound and output **ALARM**.

Top of display: **Cement timeout**

Status bar: **PAUSED: Resume to cont. cycle**

<Resume> (F1) Overrides the **Cement timeout** and resumes the mix cycle.

The maximum permitted waiting time is defined on a per recipe basis by **Cement timeout**.

Water limit

If **Water limit** is exceeded the system automatically pauses the mix cycle and the system will sound and output **ALARM**.

Top of display: **Water limit exceeded**

Status bar: **PAUSED: Abort for Mix Complete.**

<Resume> (F1) Overrides the **Water limit** and resumes the mix cycle.

The maximum amount of water that should be added to a recipe is defined on a per recipe basis by **Water limit**.

Plus tolerance

Plus tolerance defines the level *above* the target moisture at which the moisture of the mix is recognised as being 'too high'.

If the moisture at the end of the mix cycle exceeds this level the system will sound and output **ALARM**.
Disabled after mix complete

Top of display: **!Moisture too high!**

Status bar:  **to Ack & Mix Complete**

Minus tolerance

The **Minus tolerance** recipe parameter defines the level *below* the target moisture at which the moisture of the mix is recognised as being 'too dry'.

If the moisture at the end of the mix cycle is below this level the system will sound and output **ALARM**.
Disabled after mix complete..

Top of display: **!Mix too dry!**

Status bar:

<Abort> (F2): Allows the current mix to be aborted. When pressed the option to generate **MIX COMPLETE** signal is prompted with the following "**Mix Complete Required?**", **<Yes>** (F2) and **<No>** (F3). If 'No' is selected it will return to the **Start Menu**. If 'Yes' is selected the mix complete signal is generated and **<Reset>** (F2) returns to the **Start Menu** and clears the **MIX COMPLETE** signal.

<Trim> (F3) Opens the **FINE WATER** valve all the time the key is depressed, allowing manual adjustment of the moisture level.

Trim and Update

Pressing **<Pause>** (F2) at any phase in the mix cycle will pause the cycle and any water addition. Messages showing the current status and at what phase the mix cycle has been paused will be shown, for example.

Top of display: **Paused: Final wet**

Status bar: **PAUSED - Abort for Mix complete**

The following options will be available:

<Resume> (F1): Continues the cycle from the point where it was paused.

<Abort> (F2): Allows the current mix to be aborted. When pressed the option to generate **MIX COMPLETE** signal is prompted with the following “**Mix Complete Required?**”, **<Yes>** (F2) and **<No>** (F3). If ‘No’ is selected it will return to the **Start Menu**. If ‘Yes’ is selected the mix complete signal is generated and **<Reset>** (F2) returns to the **Start Menu** and clears the **MIX COMPLETE** signal.

<Trim> (F3) Opens the **FINE WATER** valve all the time the key is depressed, allowing manual adjustment of the moisture level.

<Update> (F5) Followed by  saves the adjusted water amounts and moisture levels to the current recipe.

The availability and function of the **<Trim>** and **<Update>** keys depend on the **control mode** and **phase** of the mix cycle as shown in the table below. The shaded cells indicate the phases for which **<Trim>** is available and the text indicates which recipe parameters are updated when **<Update>** is pressed.



	Pre-wet	First Mix	Final wet	Wet Mix	Mix complete
Auto	Pre-wet water and Pre-wet target	Pre-wet water and Pre-wet target	Moisture target	Moisture target	Moisture target
Pre-set	Pre-wet water and Pre-wet target	Pre-wet water and Pre-wet target	Moisture target Preset final	Moisture target Preset final	Moisture target Preset final
Calibration	-	-	-	-	Moisture target Final water & Calc %
Calculation	Pre-wet water and Pre-wet target	Pre-wet water and Pre-wet target	-	<i>No Update (see Water trim)</i>	<i>No Update (see Water trim)</i>

Mix Log

Mix Log					Rec./Batch
No.	Dry %	Calc %	Final %	W/C	1 / 3 Pre-set
00/01P	2.5	-	2.5	0.00	Moisture --.--
35/05C	3.9	9.5	6.7	0.00	
35/05C	3.9	9.6	6.8	0.00	
38/05C	0.8	20.9	3.1	0.00	
39/05C	0.8	20.9	4.0	0.00	
38/05C	0.8	6.7	7.3	0.00	Run Time -- 5
01/10P	-	-	-	0.00	
00/01P	-	-	-	0.00	
01/01P	-	-	-	0.00	
02/01P	-	-	-	0.00	
Status:					
US	Water	Mix	More..	Back	

Figure 16 – Mix Log (sensor readings)

Using the Mix Log menu

The **Mix Log** contains information on the last 99 mix cycles. On entering the **Mix Log** the most recent mix cycles are displayed. Previous mix cycles may be viewed by using the up  and down  keys

- <US>** (F1) Displays the sensor readings in unscaled values for the mixes. Repeated key presses will cycle between displaying % units and unscaled values.
- <Water>** (F2) Displays the actual water and target water for the mixes.
- <Mix>** (F3) Displays details of the mixes including total time and the weight.
- <Back>** (F5) Returns to the previous menu.
- <More>** (F4) Displays the following additional menu items:
 - <Calib>** (F1) Enables a previous mix to be used to calibrate the recipe.
 - <Dev>** (F2) Displays the sensor readings from the dry and wet phases as in the sensor readings page, and also the variation of the sensor readings (deviation) at the end of each phase. They can be in unscaled or moisture values, depending on which is set in the previous menu.
 - <Reset>** (F4) Clears the **Mix Log**; confirmation by pressing  is required before the **Mix Log** is cleared.
 - <Back>** (F5) Returns to the previous menu.

Mix Log Parameters

The first column in each of the three pages of the **Mix Log** is an identifier. The identifier consists of the **Batch number**, the **Recipe number** and the mix control mode with the following format:

<Batch number>/<Recipe number><Control mode>

Where <Control mode> is

- P** for **Preset** mode
- A** for **Auto** mode
- C** for **Calc** mode
- Q** for **Calib** mode

For example, **04/01Q** is batch 4, recipe 1, **Calib** mode

Sensor Readings Page

The first page contains information about the sensor readings for each mix cycle.

Dry US/%: The moisture in unscaled or % reached at the end of the **First mix time**.

Calc US/%: The **target** in unscaled or % of an **Auto mode, Calc mode** or **Calib** mode mix cycle.
For a **Preset** mode mix cycle no value will be shown.

Final US/%: The moisture in unscaled or % reached at the end of a mix cycle.

W/C: The water/cement ratio reached at the end of the mix cycle. This parameter will only be calculated if a cement weight is entered in the recipe. The calculation uses the dry moisture reading together with the amount of water subsequently added, therefore the accuracy depends on the calibration of the recipe and the accuracy of the dry reading.

Water Information Page

Mix Log					Rec./Batch
No.	Pre L	Calc L	Tot. L	Trim L	1 / 3 Pre-set
00/01P	0.0	-	0.0	-	Moisture
35/05C	0.0	68.9	76.0	8.0	
35/05C	0.0	70.6	78.0	8.0	
38/05C	0.0	250.2	2150.0	8.0	
39/05C	0.0	250.2	241.0	8.0	---,---
38/05C	0.0	73.5	81.0	8.0	
01/10P	0.0	-	0.0	-	Run Time
00/01P	0.0	-	0.0	-	-- 5
01/01P	0.0	-	0.0	-	
02/01P	0.0	-	0.0	-	
Status:					
US	Water	Mix	More..	Back	

Figure 17 – Mix Log (water information)

The water page of the **Mix Log**, accessed by pressing **<Water>** (F2), contains information about the water added for each mix cycle. The water added will be shown in units selected by the **Water mode** parameter (see section Setup System). The above figure shows the **Mix Log** with the **Water mode** set to **Metric**.

- Pre L:** The amount of water added to the mix during the pre-wet phase.
- Calc L:** The amount of water calculated during a **Calc** mode mix cycle.
The total amount of water added during the final wet phase(s) of a **Calib** mode mix cycle.
For **Preset** mode and **Auto** mode mix cycles no value will be shown.
- Tot L:** The total amount of water added during the mix cycle.
- Trim L:** The value of the **Water trim** for a **Calc** mode mix cycle.

Mix Information Page

Mix Log					Rec./Batch
					1 / 3
No.	Mix s	Dry kg	Gain	Offset	Pre-set
00/01P	27	0	0.18	-3.6	
35/05C	118	1245	0.17	-1.7	Moisture
35/05C	113	1245	0.17	-1.7	---
38/05C	595	1245	0.37	-11.7	
39/05C	29	1245	0.37	-11.7	
38/05C	106	1245	0.37	-11.7	
01/10P	7592	0	0.18	-3.6	
00/01P	32	0	0.18	-3.6	
01/01P	50	0	0.18	-3.6	Run Time
02/01P	50	0	0.18	-3.6	-- 5
Status:					
US	Water	Mix	More..	Back	

Figure 18 – Mix Log (mix information)

The third page of the **Mix Log**, accessed by pressing **<Mix>** (F3), contains the following information:

- Mix s:** The total time taken to reach MIX COMPLETE.
- Dry kg:** **Dry weight** from the recipe of the mix, shown in units selected by **Water mode**.
- Gain:** **Moisture gain** from the recipe.
- Offset:** **Moisture offset** from the recipe.

The above figure shows the Mix Log with the **Water mode** set to Metric.

Sensor Deviation information

Pressing F2 will show the sensor readings, available in moisture or sensor unscaled values, at the end of the first mix time and the final mix time, along with the deviation of the signal at the end of these phases.

Mix Log					Rec./Batch
No.	Dry %	Dry Dev	Final %	Wet Dev	1 / 3
00/01P	2.5	0.0	2.5	0.0	Pre-set
35/05C	3.9	0.0	6.7	0.0	Moisture
35/05C	3.9	0.0	6.8	0.0	---
38/05C	0.8	0.0	3.1	0.0	---
39/05C	0.8	0.0	4.0	0.0	---
38/05C	0.8	0.0	7.3	0.0	---
01/10P	-	0.0	-	0.0	Run Time
00/01P	-	0.0	-	0.0	---
01/01P	-	0.0	-	0.0	---
02/01P	-	0.0	-	0.0	---
Status:					
Calib	Dev	Reset			Back

Figure 19 – Mix Log (deviation information)

The deviations can be used as an indication of how stable the signal is at the end of each phase, i.e. how homogeneous the mix is. The deviation values are calculated by recording the difference between the maximum and minimum sensor readings over a period of time at the end of the first mix and final mix times – the averaging time (see control menu parameters). Deviations should therefore be as close to zero as possible, always less than 3 unscaled units.

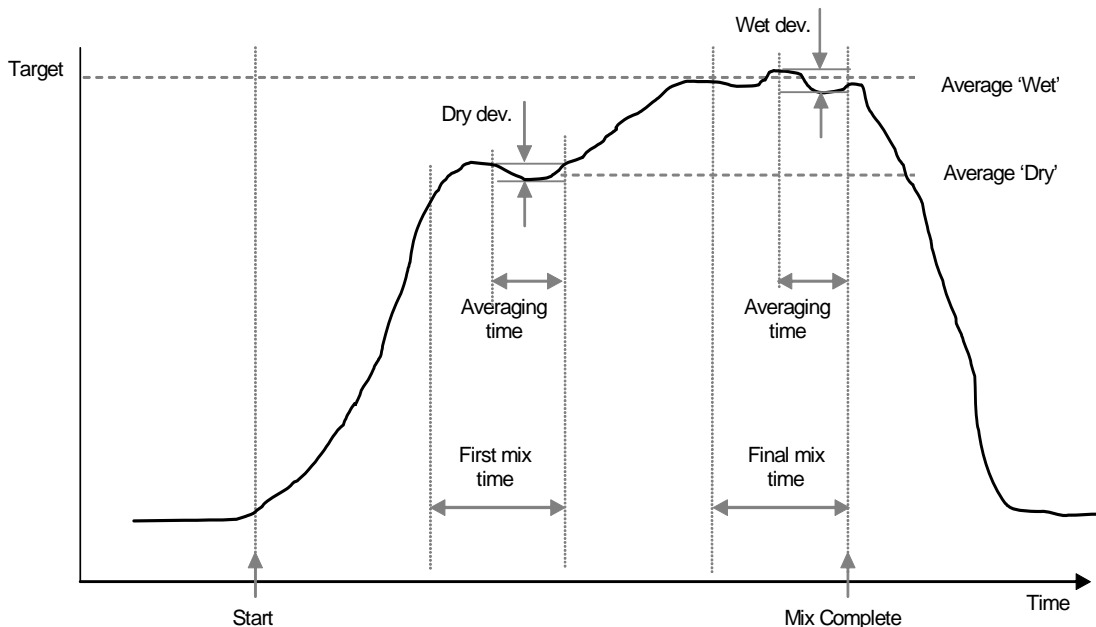

Figure 20 – Mix Log Deviations – Trend display

Calibrating from the Mix Log

When running in **Calc** mode, as mentioned, the recipe needs to be calibrated so that the controller will know the required moisture level. This calibration can be done in two ways.

The first method is to use the Calib mode as described previously on page 28.

The second method is to calibrate the recipe from a previous record in the mix log. As with all calibrations, it is essential to ensure that the moisture at the end of the first mix and the final mix times are stable, and so this should be checked before any calibration is carried out. Look at the deviations for both the first and final mix times. These should be as close to zero as possible, always less than 3 unscaled units.

To calibrate a recipe, select the required recipe that provided a good mix in the mix log. Then press **Calib** <F1> from the 'More' menu. In order for that mix data to be used for calibration, a number of checks are performed. These are:

- Water must have been added to the mix. If no water was used then the message “!Calibration failed! No water added” is shown.
- After the main water is added, the sensor’s unscaled reading must increase by at least 4 units. If the difference between the unscaled reading in the final mix and first mix are less than 4 units then the message “!Calibration failed! Low moisture variation” is shown.
- There must be a dry weight in the recipe. If no dry weight is present in the recipe, it is possible to enter this weight at the beginning of this procedure. The page will change to the following. Enter the dry weight and press the  to accept.

Mix Log		Rec./Batch	
<div style="border: 1px solid black; padding: 10px; text-align: center;"> <p>Enter Dry Weight</p> <p>1000</p> <p>✓ to save</p> </div>		6 / 1	
		Pre-set	
		Moisture	
		--.--	
		Run Time	
		-- 5	
Status:			

Figure 21 – Calibrating from mix log (enter dry weight)

The next stage of the calibration procedure will be to enter the reference final moisture. You may select the figure displayed or type in a new reference value using the keypad. Once updated, this will change the moisture target in the recipe.

Mix Log		Rec./Batch
<div style="border: 1px solid black; padding: 5px; text-align: center;"> Select final moisture % = 5.5 X to cancel ✓ to save </div>		6 / 1 Pre-set
		Moisture --.--
		Run Time -- 5
Status:		

Figure 22 – Calibrating from mix log (enter final moisture)

The next screen will enable the user to input a theoretical trim on the calibration. This might be useful if the particular batch in the mix log was a little too wet or too dry. Adding or subtracting a trim here will then adjust the calibration as if the batch was made with a different quantity of water. For example a batch is made with 30 litres. This is a little too wet by only about 2.5. Therefore using a trim of -2.5 litres would calculate the calibration as if 27.5 litres was used.

Mix Log		Rec./Batch
<div style="border: 1px solid black; padding: 5px; text-align: center;"> Trim Water For Good Mix = -2.5 X to cancel ✓ to save </div>		6 / 1 Pre-set
		Moisture --.--
		Run Time -- 5
Status:		
+/-		

Figure 23 – Calibrating from mix log (enter trim water)

After this, the calibration can be saved and the recipe will be updated with the new parameters.

Setup System

Setup System		Rec./Batch
Hydro-Control V v5.00 Password:		1 / 3 Pre-set
		Moisture ---.---
		Run Time -- 5
Status:		
System		Back

Figure 24 – Setup System

Using the Setup System Menu

The **Setup System** menu is accessed by pressing **<More...>** from the **Start Menu** and then **<Setup>** (F1). The **Setup System** menu is displayed with a prompt for a four-digit password. None of the function keys, with the exception of **<Back>** (F5) will operate until the correct password has been entered:

- Enter the password by typing the correct 4 digits. The words **'Incorrect'**, **'Correct'** or **'Advanced'** will then be displayed to confirm correct entry or warn of incorrect entry.
- If an incorrect password is entered then you must use the **<Back>** (F5) key to return to the Start Menu.
- If the standard password has been entered then the **<System>** (F1) and **<Diag>** (F2) function keys will be available.
- If the advanced password has been entered then the **<System>** (F1), **<Diag>** (F2), **<Control>** (F3) and **<Valve>** (F4) function keys will be available.

<System> (F1)	Edit the system parameters
<Diag> (F2)	Enter sensor diagnostics
<Control> (F3)	Edit the control parameters
<Test> (F4)	Enter the system test menu
<Back> (F5)	To return to the Start Menu

Edit System Parameters

Edit System		Rec./Batch
Water mode : Metric		1 / 3
Meter flow/pulse : 1.000000		Auto
Meter timeout : 5		Moisture
Language : English		--.--
Busy mode : Water		Run Time
Max. recipes : 10		-- 5
Default recipe...		
Status:		
Inc	Dec	Back

Figure 25 – Edit System

Parameter	Units	Default	Range
Water mode	None		Timed, US, Metric
Meter flow/pulse		1.000000	0 – 9.999999
Meter timeout	Seconds	5	0 – 99
Language	None	English	English, French, German, Dutch, Spanish, Italian, Finnish, Danish
Busy mode	None	Water	Water, Admix, All
Max recipes	None	10	1 - 99

Water mode: Determines how the water is measured into the mixer. If you have no water meter use 'Timed', otherwise select 'US' (US Gallons, lbs and degrees Fahrenheit) or 'Metric' (litres, kg and degrees Centigrade) to match your system.

Meter flow/pulse: The quantity of water measured by each pulse of the water meter

Meter timeout: If no water pulses are received within this time after opening the valve then an alarm is generated and the system will pause.

Language: Defines the language used for the information messages.

Busy mode: This can be set to one of three values:

- **Water:** Busy signal is high only during **Pre wet** and **Final wet** phases.
- **Admix:** Busy signal is high during the **Final wet** phase.
In a 2-stage calibration mix cycle the signal is high for the *second* **Final wet** phase only.
- **All:** Busy signal is high during entire mix cycle.

Max recipes: Defines the number of recipes available.

Default recipe parameters

Scrolling down to the 'Default recipe...' statement at the bottom of the list will display the first page of the Default recipe. These parameters are identical to those in every other recipe and can be edited in the same way (see section **Edit Recipe**).

System Test

<Valve> F1: Manually test coarse and fine valves

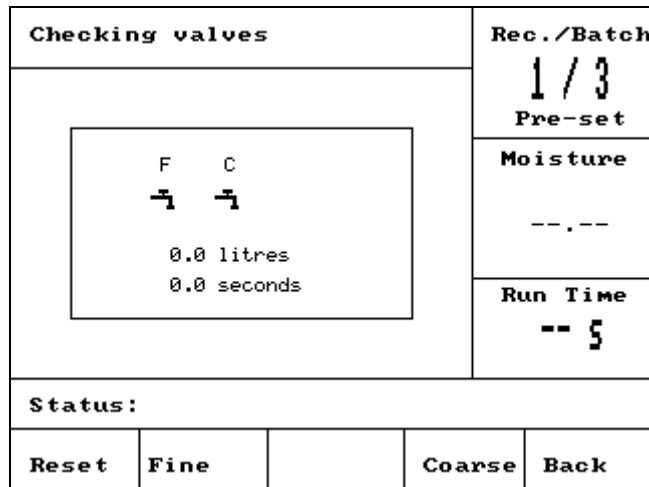

Figure 26 – Checking Valves

- <Reset> (F1): Resets the water added and the time elapsed shown in the display box to zero.
- <Fine> (F2): Activates the **FINE WATER** output all the time the key is depressed and will stop when the key is released. The amount of water added and the time elapsed are shown in the display box.
- <Coarse> (F4): Activates the **COARSE WATER** output all the time the key is depressed and will stop when the key is released. The amount of water added and the time elapsed are shown in the display box.
- <Back> (F5): Returns to the **Setup System** menu

<HCV> F2: Hydro-Control V hardware tests

Hydro-Control V hardware tests

<Display> F1: Generates a display test screen

<Input> F2: View state of inputs

<Output> F3: Manually control state of outputs

Use the up  and down  keys to select output.

<off> F1: turns selected output off

<on> F2: turns selected output on

<Keys> F4: Shows a mimic of the keypad and displays keys pressed

Edit Control Parameters

Edit Control		Rec./Batch
Gain : 40	<	1 / 3 Auto
Upper control thr.: 70		Moisture
Lower control thr.: 25		--.--
Valve onoff time : 1.0		Run Time
Fine delivery : 20.0		-- 5
In-flight -lits : 0.0		
Averaging Time : 10		
Mix Extension : 30		
Access mode : Unlock		
More..		
Status:		
Inc	Dec	Back

Figure 27 – Control Menu (first page)

NOTE: INCORRECT VALUES MAY STOP THE SYSTEM FROM WORKING PROPERLY. CHANGES SHOULD ONLY BE MADE BY COMPETENT OPERATORS.

The control algorithm used in **Auto** mode attempts to make a compromise between achieving the moisture target as quickly as possible and on the other hand, not letting the moisture level overshoot the target level. The factors that affect this compromise include:

- How rapidly can your mixer make a homogeneous load?
- How long after water addition starts will the moisture level near the sensor increase? (This depends upon sensor placement)
- What is the flow rate of water through the coarse and fine valves?
- What is the load size?
- How quickly can you turn your valves on and off?
- How often can you turn your valves on and off?
- What variation in moisture content can you tolerate?

Adjusting the various control parameters permits optimisation to suit local conditions. The Hydro-Control V has been designed and configured so that most users will never need to know the details of the control method used and will not need to change the settings. However if your mixer system is unusually fast or slow in its response, and you are familiar with system control methods and theory, you might be able to optimise your system response time by adjusting the default parameters.

Control parameters

Parameter	Units	Default	Range
Gain	None	45	0-999
Upper Control Threshold	None	70	0-99
Lower Control Threshold	None	25	0-99
Valve on/off Time	Seconds	1.0	0.0 – 99.9
Fine delivery	Litres, Gallons, seconds	20.0	0 – 99.9
In-flight	Litres, Gallons, seconds	0	0 – 999.9
Averaging time	Seconds	10	0 – 999
Mix extension	Seconds	30	0 -999
Access mode	None	Unlock	Unlock/lock
Valve – Pre-wet	None	Both	Both/Fine/Coarse
Valve – Final-wet	None	Both	Both/Fine/Coarse

Gain; Upper Control Threshold; Lower Control Threshold; Valve on/off Time:

- See section **Auto Mode Control Parameters**.

Fine delivery: When a fixed amount of water is being added to a mix the last 'fine delivery' litres of the water will be added using the fine valve only.

NOTE: Setting this parameter to be greater than 99 will ensure that *only* the fine valve is used for any mix cycle.

In-flight: The amount of water that continues to flow into the mixer after the valve output has been switched off. **Calc** mode mix cycles require this value to be set correctly in order for calculations to be performed accurately.

Averaging time: During the mix phases of any mode mix cycle the system will average the moisture values over this period of time.

Mix extension: During a calibration run, the system will extend the final mix time by the Mix extension time to ensure that a good final reading is obtained.

Access mode: When set to **Lock**, prevents editing of recipe parameters and allows user to change only between the current mix cycle mode and Preset mode (In the case that signal is lost from the sensor it is still possible to run the recipe in preset mode).

Valve – Pre-wet: Selects the valve used during Pre-wet phase. Can be set to **Both** (default setting), **Fine** only or **Course** only.

Valve – Final-wet: Selects the valve used during Final-wet phase. Can be set to **Both** (default setting), **Fine** only or **Course** only.

Note: When using only one valve for water input, it is always recommended to connect to the 'Fine Valve' output. In such cases it is not necessary to change the above valve parameters to 'Fine' as the default setting of 'Both' will always work.

Diagnostics

Diagnostics		Rec./Batch		
		1 / 3		
		Auto		
		Moisture		
		--.--		
		Run Time		
		-- 5		
Status:				
H/W	RES	MON	CONF	Back

Figure 28 – Diagnostics

The Diagnostics screens are only used for troubleshooting and will normally only be accessed after instruction from Hydronix.

Using the Diagnostics Menu

The diagnostics menu provides access to several screens that can be used to read, test and configure the connected sensor:

- To read system information and test the Current Interface press **<H/W>** (F1)
- To view a graphical display of the resonator press **<RES>** (F2)
- To monitor the measurements made by the sensor press **<MON>** (F3)
- To configure the sensor press the **<CONF>** (F4) key

Press **<Back>** (F5) to return to the Setup System Menu.

Hardware

Hardware		Rec./Batch		
Current 0.00		Calib		
UncompFreq. : 830.8 MHz		Moisture		
Comp.Freq. : 830.8 MHz		--.--		
Amplitude : 673		Run Time		
Sensor : 263CFB90		.		
Firmware : HS0063 v2.12				
Temp-C: Min 11.3 Max 37.7				
Air : 828.30 Water: 784.30				
Status:				
		Test	Calib	Back

Figure 29 – Hardware

Using the Hardware Menu

The Hardware Menu displays information about the connected sensor, and allows the user to force the analogue output of the sensor and to autocal a Hydro-Probe Orbiter.

To test the sensor analogue output, select 'Test' <F3>. This will force the current to the indicated value. Use the numeric keypad or the <Inc> (F1) and <Dec> (F2) keys to vary the current between 0 – 20mA.

NOTE: The current interface is not normally used when connected to a Hydro-Control V.

The 'Calib' function shown above in <F4> only appears when a Hydro-Probe Orbiter is connected. This is used to perform an **Autocal** which is used when a new sensing arm is connected to the sensor.

The Hardware menu will also display the following information:

- Uncompensated and compensated frequency
- Amplitude of frequency response
- Sensor ID
- Firmware Version
- Min and Max temperatures recorded in the sensor
- Factory calibration air and water readings

Press the <Back> (F5) key to return to the Diagnostics Menu.

Resonator

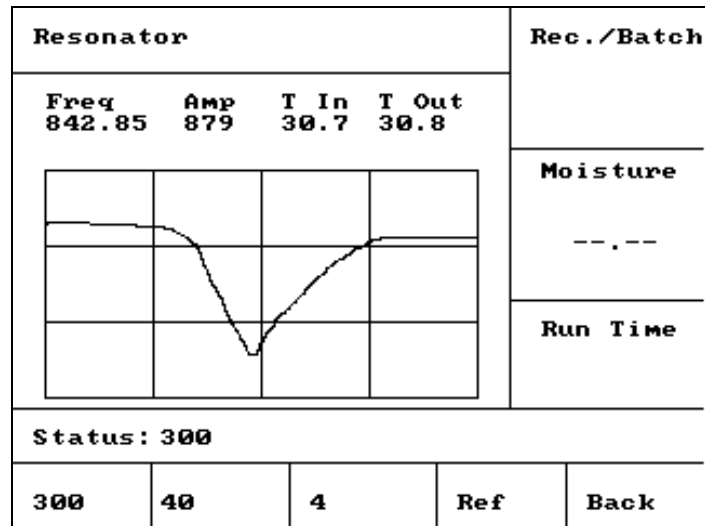

Figure 30 – Resonator

Using the Resonator Menu

The output from the resonator is displayed graphically. Above the graph, the values of the resonant frequency, the amplitude of the resonance and the internal and outside temperatures (°C) are shown.

- To view the 300MHz sweep press **<300>** (F1)
- To view the 40MHz sweep press **<40>** (F2)
- To view the 4MHz sweep press **<4>** (F3)
- To view the reference signal press **<Ref>** (F4)

To return to the Diagnostics Menu press **<Back>** (F5)

Monitor

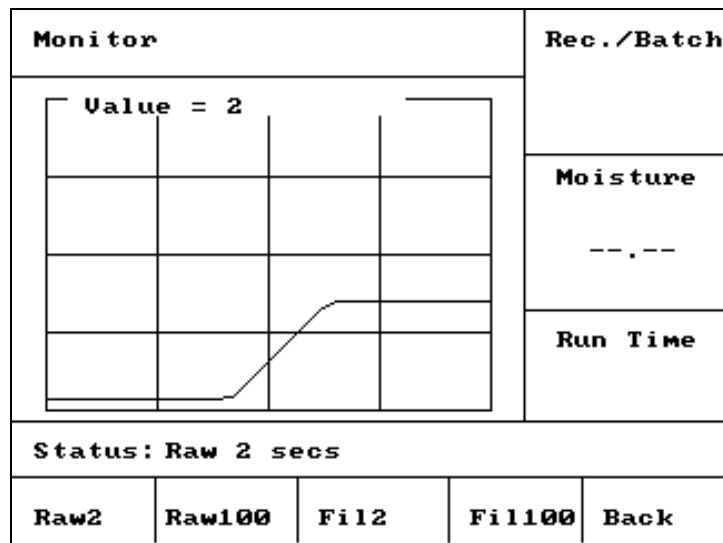

Figure 31 – Monitor Sensor Readings

Using the Monitor Menu

The Monitor Menu allows graphical display of the Raw or Filtered unscaled readings. The current instantaneous value is shown numerically at the top centre of the graph. Viewing options are:

- To view the Raw readings with a 2 second time-base press the **<Raw2>** (F1) key.
- To view the Raw readings with a 100 second time-base press the **<Raw100>** (F2) key.
- To view the Filtered readings with a 2 second time-base press the **<Fil2>** (F3) key.
- To view the Filtered readings with a 100 second time-base press the **<Fil100>** (F4) key.

To return to the Diagnostics Menu press the **<Back>** (F5) key.

Sensor Configuration



Sensor Configuration		Rec./Batch
O/P type	: 0-20mA <	1 / 3
O/P variable	: fil u/s	Pre-set
I/P 1	: None	Moisture
I/P 2	: None	---
Ave/hold delay	: 0.0 s	Run Time
Filtering time	: 1.0 s	-- 5
Slew rate +	: None	
Slew rate -	: None	
Status:		
Inc	Dec	Calib Back

Figure 32 – Sensor Configuration

Using the Sensor Configuration Menu

The sensor configuration parameters can be viewed and edited here.



These should not be changed after commissioning as this could adversely affect system performance.

To change a parameter, move the cursor (<) to the parameter required using the up  and down keys: 

Type the desired value using the numerical keypad or use the <Inc> (F1) and <Dec> (F2) keys to increment or decrement the value.

The 'Calib' function shown above in <F4> only appears when a Hydro-Probe Orbiter is connected. This is used to perform an **Autocal** which is used when a new sensing arm is connected to the sensor.

After completion of editing press <Back> (F5) and then either of the following keys:

-  to save the changed values and return to the Diagnostics Menu
-  to cancel and return to the Diagnostics Menu. Choosing this option will return any edited parameters to their original values.

Sensor Configuration Parameters

Parameter	Units	Default	Range
Output type	None	0-20 mA	0-20mA, 4-20mA, Compatibility
Output variable	Unscaled units	Filtered	Filtered, Raw
I/P 1	None	M/T	None, M/T
I/P 2	None	None	None
Ave/hold delay	Seconds	0.0	0.0, 0.5, 1.0, 1.5, 2.0 or 5.0
Filtering time	Seconds	7.5	0.0, 1.0, 2.5, 5.0, 7.5 or 10.0
Slew rate +	None	Light	None, Light, Medium, Heavy
Slew rate -	None	Light	None, Light, Medium, Heavy

Output type: Sets the analogue output characteristics of the sensor to the required type. *Not used by the Hydro-Control V but available from sensor.*

Output variable: Determines which variable is available on the sensor analogue output:

- Filtered - Unscaled reading filtered using the sensor **filtering time** and **slew rates**.
- Raw – Unscaled reading with *no* filtering applied.

I/P 1: Digital input to sensor that can be configured to:

- None – status of input is ignored.
- M/T – switch analogue output between a signal proportional to moisture and a signal proportional to external (material) temperature.

I/P 2: This parameter is not relevant to Hydro-Control V and will always be set to 'None'.

Ave/hold delay: **Always** set to 0.0 for mixer applications.

Filtering time: Determines the filtering time in a sliding window averaging process..

Slew rate + & Slew rate - : These parameters are used by the sensor to limit the effect of rapid transient signals due to mixer blades or noise spikes on the electrical supply lines. They set, respectively, the maximum positive and negative voltage change allowed between successive sensor readings.

The Hydro-Control V can be connected to a remote device such as a programmable logic controller (PLC) for remote recipe selection or a batch control computer for remote recipe selection and reading of various parameters for logging purposes.

It can also be connected to a laptop or PC for software upgrades.

The RS232 port settings should be set as follows:

```

Baud Rate:    9600
Data Bits:    8
Parity:       None
Stop Bits:    1
    
```

RS232 Connections on Operator Terminal

The Hydro-Control V is fitted with three multi way connectors of which terminals 21, 22 and 23 are used for RS232 connection. The connections to the remote device are shown in the table below

Pin No.	Signal Name	Description
21	RS232 Rx (RxD)	Receive data. - Input
22	RS232 Tx (TxD)	Transmit data. - Output
23	RS232 Gnd (Gnd)	Signal ground.

Sending Remote Commands

This section describes the commands that the PLC/batch controller must send to the Hydro-Control V to instruct it to carry out the required operations.

Note: All commands are terminated with a 'Carriage Return' code, ASCII 13.

Also note that the position of spaces between command characters is important. In the next sections, the character " _ " represents a space and must be used where shown

To prevent accidental changes that may produce undesirable effects, some commands are only valid during certain parts of the cycle. These are shown below.

For example:

- Changing the active recipe can only be done when the Hydro-Control V is in standby phase (since changing a recipe in the middle of an active mix phase will probably produce an erroneous mix). Response will be 'Not While Active' if attempted during any other phase.
- 'Mix complete at' is only meaningful during the mix complete phase; the parameter will return zero at all other phases.

NOTE: During operation, 'noise' on the RS232 connection may be interpreted as characters by the Hydro-Control V. Sending a 'Carriage Return' code, ASCII 13, will clear the input buffer, and generate a ?10 response. The Hydro-Control V will now be ready for receiving valid remote commands.

Selecting Recipes

To select recipe No. *nn* , send a message in the form:

Format	Terminator	Parameter Range	Valid Period	Response	Response Terminator
>R1= <i>nn</i>	ASCII 13	<i>nn</i> = 1 to 99	Stand By	!	ASCII 13

For example, to select recipe 10:

- Send the ASCII string: >R1=10 Do not forget the ASCII 13 terminator.
- Note there are no spaces in this command.

Setting Dry Weight in Current Recipe

Format	Terminator	Parameter Range	Valid Period	Response	Response Terminator
>D1= <i>nnnnn</i>	ASCII13	<i>Nnnnn</i> = 1 to 32000	Stand By	!	ASCII 13

Reading Current Moisture value

The current moisture value can be read by sending a message in the form:

Format	Terminator	Parameter Range	Valid Period	Response	Response Terminator
*2	ASCII 13		Any	xx.yy	ASCII 13

e.g. if the current moisture is 5.61% then the response to *2 will be 5.61

If the final moisture target achieved is required for record purposes then Mixer Status command should be used, see later in this chapter.

Reading the software version string

The software version identification string (as used at start up) can be accessed by sending a message in the form:

Format	Terminator	Parameter Range	Valid Period	Response	Response Terminator
*3	ASCII 13		Any	Hydro-Control V v 1.10	ASCII 13

The reply is the ASCII version string displayed at start up.

Downloading the mix log

The mix log can be downloaded by sending a message in the form:

Format	Terminator	Parameter Range	Valid Period	Response	Response Terminator
*4	ASCII 13		Any	All current mix logs.	Each log: ASCII 13

Reading current Temperature value

The current temperature value (°C or °F) can be read by sending a message in the form:

Format	Terminator	Parameter Range	Valid Period	Response	Response Terminator
*5	ASCII 13		Any	xx.y	ASCII 13

e.g. If the current temperature is 25.0 then the response to *5 will be 25.0 C.

Reading sensor unscaled reading

The sensor unscaled reading can be read by sending a message in the form:

Format	Terminator	Parameter Range	Valid Period	Response	Response Terminator
*7	ASCII 13		Any	xx.yy	ASCII 13

e.g. if the unscaled reading is 35.61 then the response to *7 will be 35.61

Download last batch from the mix log

The last batch in the mix log can be downloaded by sending a message in the form:

Format	Terminator	Parameter Range	Valid Period	Response	Response Terminator
*8	ASCII 13		Any	Last mix log	ASCII 13

Reading and writing Recipe Parameters

All the major recipe parameters can be set over the RS232 link.

To read the value of recipe parameter *pp* in recipe no. *nn* send a message in the form:

Format	Terminator	Parameter Range	Valid Period	Response
#_R_nn_pp	ASCII 13	nn = 1 to 99 pp – see below	Active recipe – Standby All other recipes Anytime	See below ?1x if unsuccessful

For example, if the final water target (parameter 7) of recipe 5 was 8.5%:

- Send the ASCII string: #_R_5_7 (Do not forget to terminate with ASCII 13, 'carriage return'.)
- Receive: 85

NOTE: It is important to include the spaces as shown.

Recipe parameters can be read by specifying the recipe number (1-99) and the parameter number (see table below).

Parameter	Description	Units	RS232 value	Actual value
4	First mix time	Seconds	10	10
5	Cement timeout	Seconds	10	10
6	Pre-wet water	Seconds, Litres or US Gallons	250	25.0
7	Moisture target	0.1 %	65	6.5
8	Preset final	Seconds, Litres or US Gallons	300	30.0
13	Final mix time	Seconds	15	15
14	Plus tolerance	0.1%	10	1.0
15	Minus tolerance	0.1%	3	0.3
17	Recipe gain	None	10	1.0
19	Moisture Offset	None	-36364	-3.6364
20	Moisture gain	None	1817	0.1817
23	Control method (0 = preset, 1 = auto, 2 = calculation)	None		
24	Dry weight	Kg or lbs	2000	2000
25	Calc. %	0.1 %	60	6.0
26	Calibration Water	Litres or US Gallons	500	50.0
27	Water limit	Litres or US Gallons	1200	120.0
28	Water trim	Litres or US Gallons	50	5.0
29	Batch counter	None	3	3
30	Pre-wet delay	Sec	10	10
31	Pre-wet target	0.1%	40	4.5
32	Pre-wet mode (0 = auto, 1 = preset)	None		
33	Cement weight	Kg or lbs	2000	2000
34	Temperature	°C or °F	250	25.0
35	Temp. Coeff.	% / °temp	200	0.2
36	Calibration Type (1=1-point, 2 = 2 point)	None		

All the major recipe parameters can be written over the RS232 link. The format and parameter list are similar to the read command, i.e. to write the value of recipe parameter *pp* in recipe no. *nn* send a message in the form:

Format	Terminator	Parameter Range	Valid Period	Response
#_W_nn_pp_vv	ASCII 13	nn = 1 to 99 pp – see above vv – see above	Active recipe – Standby All other recipes Anytime	! if successful ?1x if unsuccessful

For example, to set the final water target (parameter 7) of recipe 5 to 8.5%:

- Send the ASCII string: **#_W_5_7_85**
- Do not forget to terminate with ASCII 13, 'carriage return'.

Reading and writing System Parameters

All the system parameters (including the default recipe parameters, parameters 111 to 124) can be read and set over the RS232 link.

To read the value of system parameter *pp* send a message in the form:

Format	Terminator	Parameter Range	Response
#_R_ <i>nn</i> _ <i>pp</i>	ASCII 13	<i>nn</i> = 0 <i>pp</i> – see below	See below ?1x if unsuccessful

System parameters can be read by specifying a 'recipe' number of 0 and the parameter number (101-131, see table below).

Parameter	Description	Units	RS232 value	Actual value
101	Water Mode (0 = metric, 1 = US, 2 = timed)	None		
102	Meter Flow	Litres or US Gallons	200	0.200
103	Meter Timeout	Seconds	20	20
105	Language (0 = English, 1 = French, 2 = German, 3 = Dutch, 4 = Spanish, 5 = Italian, 6 = Finnish, 7 = Danish)	None		
106	Busy Mode (0 = All, 1 = Water, 2 = Admix)	None		
107	Pre-wet water	Seconds, Litres or US Gallons	150	15.0
108	First mix time	Seconds	10	10
109	Cement timeout	1 sec	5	5
110	Moisture target	0.1 %	65	6.5
111	Preset final	Seconds, Litres or US Gallons	350	35.0
112	Final mix time	Seconds	15	15
113	Control method (0 = preset, 1 = auto, 2 = calculation)	None		
114	Plus tolerance	0.1%	10	1.0
115	Recipe gain	None	10	1.0
116	Minus tolerance	0.1%	3	0.3
117	Moisture Offset	None	-36364	-3.6364
118	Moisture gain	None	1817	0.1817
119	Dry weight	Kg or lbs	2000	2000
120	Calc. %	0.1 %	60	6.0
121	Calibration Water	Litres or US Gallons	500	50.0
122	Water limit	Litres or US Gallons	1200	120.0

Parameter	Description	Units	RS232 value	Actual value
123	Water trim	Litres or US Gallons	50	5.0
124	Batch counter	None	3	3
125	Gain	None	20	20
126	Upper Control Threshold	None	50	50
127	Lower Control Threshold	None	50	50
128	Valve On/Off Time	Seconds	10	1.0
129	Fine Valve Tolerance	Litres or US Gallons	20	20
130	In-flight	Litres or US Gallons	50	5.0
131	Averaging time	Seconds	150	15.0
132	Samples	Seconds	1	0.1
133	Pre-wet delay	Seconds	10	10
134	Pre-wet target	0.1%	40	4.0
135	Pre-wet mode (0 = auto, 1 = preset)	None		
136	Max. recipes	None	10	10
137	Access mode (0 = unlock, 1 = lock)	None		
138	Mix Extension	Seconds	10	10
139	Cycle loops	None	2	2
140	Cement weight	Kg	2000	2000
141	Address (0-16 only)	None	5	5
142	Temperature	°C / °F	250	25.0
143	Temp. Coeff.	% / °temp	200	0.2
144	Valve – Pre-wet (0 = Fine, 1 = Coarse, 2 = Both)	None		
145	Valve – Final-wet (0 = Fine, 1 = Coarse, 2 = Both)	None		
146	Calibration Type (1=1-point, 2 = 2 point)	None		

All major system parameters can be written over the RS232 link. The format and parameter list are similar to the read command, i.e. to write a value *vv* to system parameter *pp* send a message in the form:

Format	Terminator	Parameter Range	Response
#_W_nn_pp_vv	ASCII 13	nn = 0 pp – see above vv – see above	! if successful ?1x if unsuccessful

The response will be in the same format as the read command.

Mixer Status Commands

Four commands permit interrogation of the current status.

To read the current status parameter *pp* send a message in the form:

Format	Terminator	Parameter Range	Response
#_M_nn_pp	ASCII 13	nn = 0 pp – see below	See below ?1x if unsuccessful

Parameter	Description	Units	RS232 value	Actual value
6	Current active recipe	None	1	1
12	Total water added (at Mix Complete)	Litres or US Gallons	82.20	82.20
24	Time taken to reach Mix complete (at Mix Complete)	Seconds	140	140
25	Status byte	None		
26	Moisture reading at mix complete	%	7.40	7.40

For example (if system is at **MIX COMPLETE**):

- If water added was 43.1 L, #_M_0_12 will return 43.10
- If current recipe is 17, #_M_0_6 will return 17
- If time taken to **MIX COMPLETE** was 48 secs, #_M_0_24 will return 48

If system is *not* in **MIX COMPLETE** phase, dependent values returned will be 0.00.

The **Status byte** returns an indication of the current phase of the mix cycle:

Phase	Returned value
Standby	1
Pre Wet	2
Cement call	4
First Mix	8
Final Wet	16
Wet Mix	32
Mix Complete	64
Paused	128

NOTE: For example if the system is paused in the wet mix phase, the command #_M_0_25 will return **160** since the status value is: **32** (Wet Mix) + **128** (Paused) = **160** (Total)

Command Acknowledgements

The Hydro-Control V will reply to **valid** remote commands in one of the following ways:

Code	Meaning
Value	The data requested from a valid command. Value may be in integer, floating point or string format.
!	Message processed without error (only issued if command returns no data)

The Hydro-Control V replies to all **invalid** commands with one of the following responses:

Value	Meaning
?10	Invalid command
?11	Parameter 1 out of range
?12	Parameter 2 out of range
?13	Parameter 3 out of range
?14	Command not valid while mix active

All replies are terminated with a carriage return (ASCII code 13).

Connecting to a PC/Laptop

The upgrade utility uses the Hydro-Control V RS232 serial connections and you will need the appropriate connecting cable as described below.

Connect the COM port of the PC/Laptop to the RS232 connections on the Hydro-Control V using the following diagram:

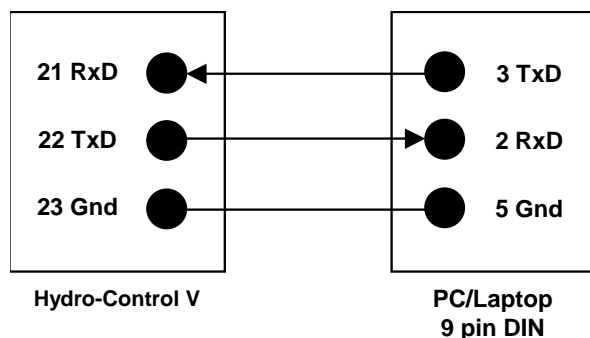

Upgrading Software

Due to Hydronix commitment to continuous improvement of their products, upgraded versions of the system software may be released.

Any new software versions and the utility to upgrade the Hydro-Control V are available on the Hydronix web site <http://www.hydronix.com/>

Using the Hydro-Control V Upgrade Utility

An upgrade facility is available from Hydronix. This utility is run from a PC using the RS232 serial port on the Hydro-Control V. This allows the ability to upgrade the Hydro-Control V whilst on site.

Note that when upgrading, the system parameters, control parameters and recipe data will return to their default value. The upgrade utility therefore has a backup and restore feature which will allow the parameters to be downloaded onto the computer, then uploaded again so that the Hydro-Control V will once more be fully functional.

Switching into Upgrade Mode

- Switch off the Hydro-Control V.
- With the  key depressed, switch on the Hydro-Control V. This will place the unit into upgrade mode.



Warning: Whilst performing upgrade – please ensure the power is stable for the complete duration. The upgrade takes approximately 10 minutes. If a problem with the power supply occurs at the end of this procedure it could cause the Hydro-Control V to become inoperable and in such a situation would need to be repaired by Hydronix.

This chapter describes how to install the Hydro-Control V, including connection of the Hydronix moisture sensor and the RS485/RS232 communications link.

Unpacking the unit

Remove the Hydro-Control V from its packing and check for any transit damage or loose parts. In the event of any problems contact Hydronix or your local supplier.

Safety Instructions

The Hydro-Control V has been designed in accordance with the recommendations of IEC 664 and has been supplied in safe condition.

This unit is suitable for indoor use only.



If the equipment is used in a manner not specified by the manufacturer the protection provided by the equipment might be impaired.

Precautions

Disconnect from voltage supply before the unit is opened for any adjustment, maintenance or repair work.

Ensure that only fuses of the correct type and rating are fitted.

Ensure that the Hydro-Control V is mounted in an environment that will not cause electrical interference.

Explanation of Symbols and Markings

It is important to understand the meaning of the various symbols and markings on the Hydro-Control V equipment as follows: -



Caution, refer to accompanying documents.



Caution, risk of electric shock.

Ventilation Requirements

It is important to ensure that the Hydro-Control V has adequate ventilation and that the side vents are not restricted.

The recommended clearance for the sides of the enclosure is 100mm.

Protection From Lightning Strikes

You should give some consideration to protecting the Hydronix installation from damage caused by lightning and similar electrical disturbances.

Many installations will be in situations that are particularly prone to damage by lightning, for example:

- Tropical Regions.
- Outdoor installations.
- Long cable runs between the sensor and the control panel.
- Tall, electrically conductive constructions (e.g. aggregate bins).

Although the Hydro-Control V is fitted with Opto-Isolation on the sensor input, this will not prevent damage in all cases. Precautions should still be taken to avoid damage by lightning in areas where there is a known risk.

We would recommend the installation of suitable lightning barriers to all conductors in the sensor extension cable. Ideally, these would be fitted at both ends of this cable to protect both the sensor and the Hydro-Control V plus any other equipment connected to it.

Installing the Hydro-Control V

The Hydro-Control V is mounted in a control panel (maximum thickness 10mm) as described below: -

- Cut out an aperture in the panel: 178 mm High x 232 mm Wide (7.01 in x 9.13 in)
- Remove the pair of mounting brackets from the Hydro-Control V by releasing the screws and unhooking the brackets from the body of the unit.
- Insert the Hydro-Control V through the prepared hole.
- Re-fit the mounting brackets to the unit and tighten the screws to pull the fascia towards the control panel. Do not over-tighten as this may distort the fascia plate.

Wiring Connections

The wiring connections for the Hydro-Control V are shown in Figures 36, 37 & 38.

The sensor must be connected using an extension cable made up from a suitable length of two pairs twisted (4 cores total) screened (shielded) cable with 22 AWG, 0.35mm² conductors. It is recommended that a high quality cable with good braid screen and also a foil screen is used in order to minimise the possibility of interference. Recommended cable types are Belden 8302 or Alpha 6373. The cable screen must be connected at the sensor end only, and therefore it is essential that the sensor body has a good connection to an electrical earth.

The cable run from the sensor to the control unit must be separate from any heavy equipment power cables, particularly the power cable for the mixer. Failure to separate the cable runs can lead to signal interference.

Input / Output Module Types

The Hydro-Control V is fitted with plug-in optically isolated input/output modules, manufactured by OPTO-22. A range of different input/output modules is available.

Digital Input Module Types

Hydronix Part No.	OPTO-22 Part No.	Description
0401	G4IDC5	10 - 32 VDC
0402	G4IAC5	90 – 140VAC
0403	G4IAC5A	180 – 280VAC

Digital Output Module Types

Hydronix Part No.	OPTO-22 Part No.	Description
0404	G40DC5	5 - 60VDC @ 3A (45°C), 2A (70°C).
0405	G40AC5	12 – 140VAC @ 3A (45°C), 2A (70°C).
0406	G40AC5A	24 – 280VAC @ 3A (45°C), 2A (70°C).

Connecting Ancillary Equipment

The Hydro-Control V provides no operating voltage for any external equipment other than the Hydronix moisture sensor. All external equipment (valves, water meter, alarms, relays etc.) must be provided with power from an external supply. An example plant-wiring schedule is shown in Fig 38.

Mix Sequence Diagrams

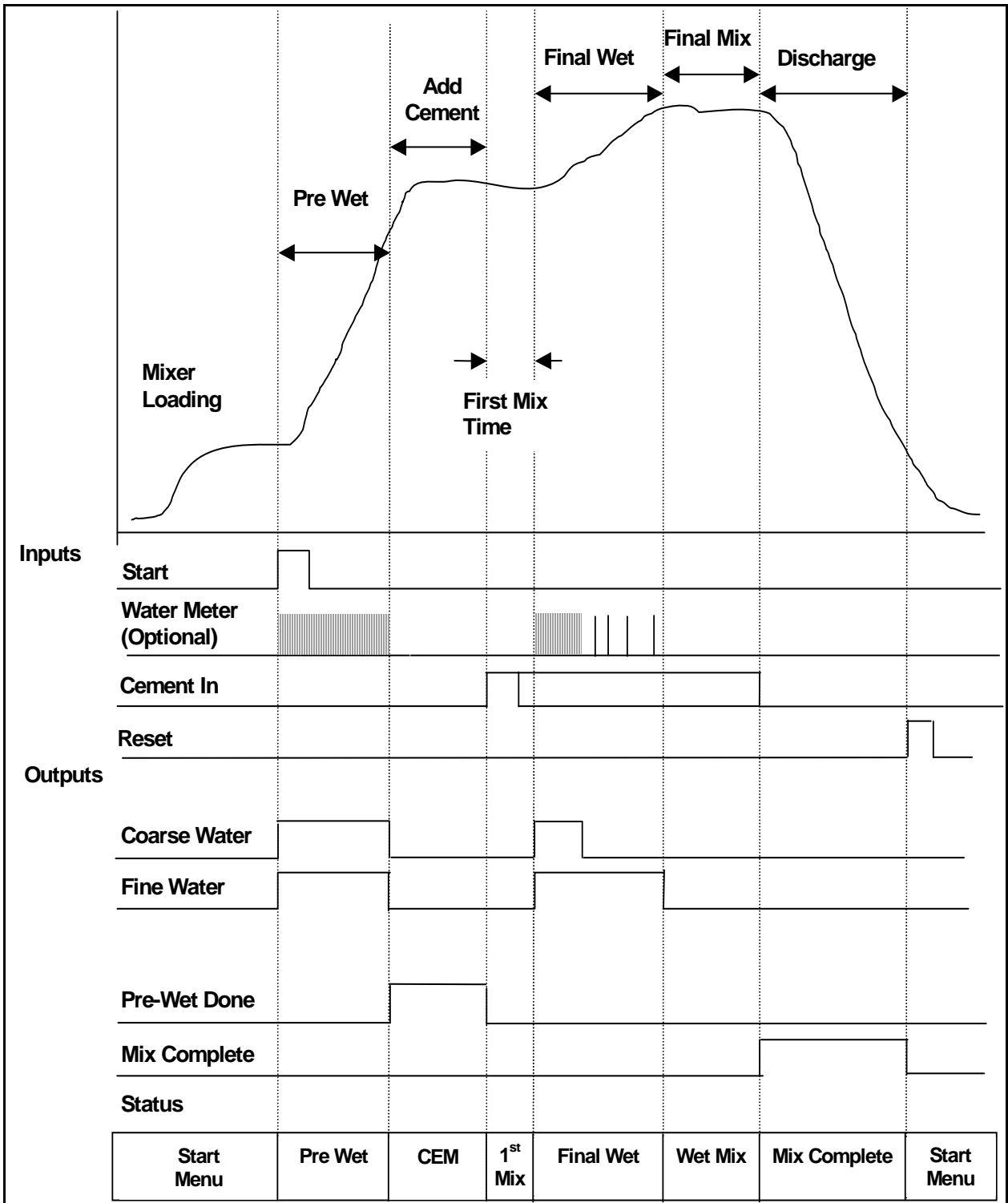

Figure 33 – Pre-Wet Mix Cycle

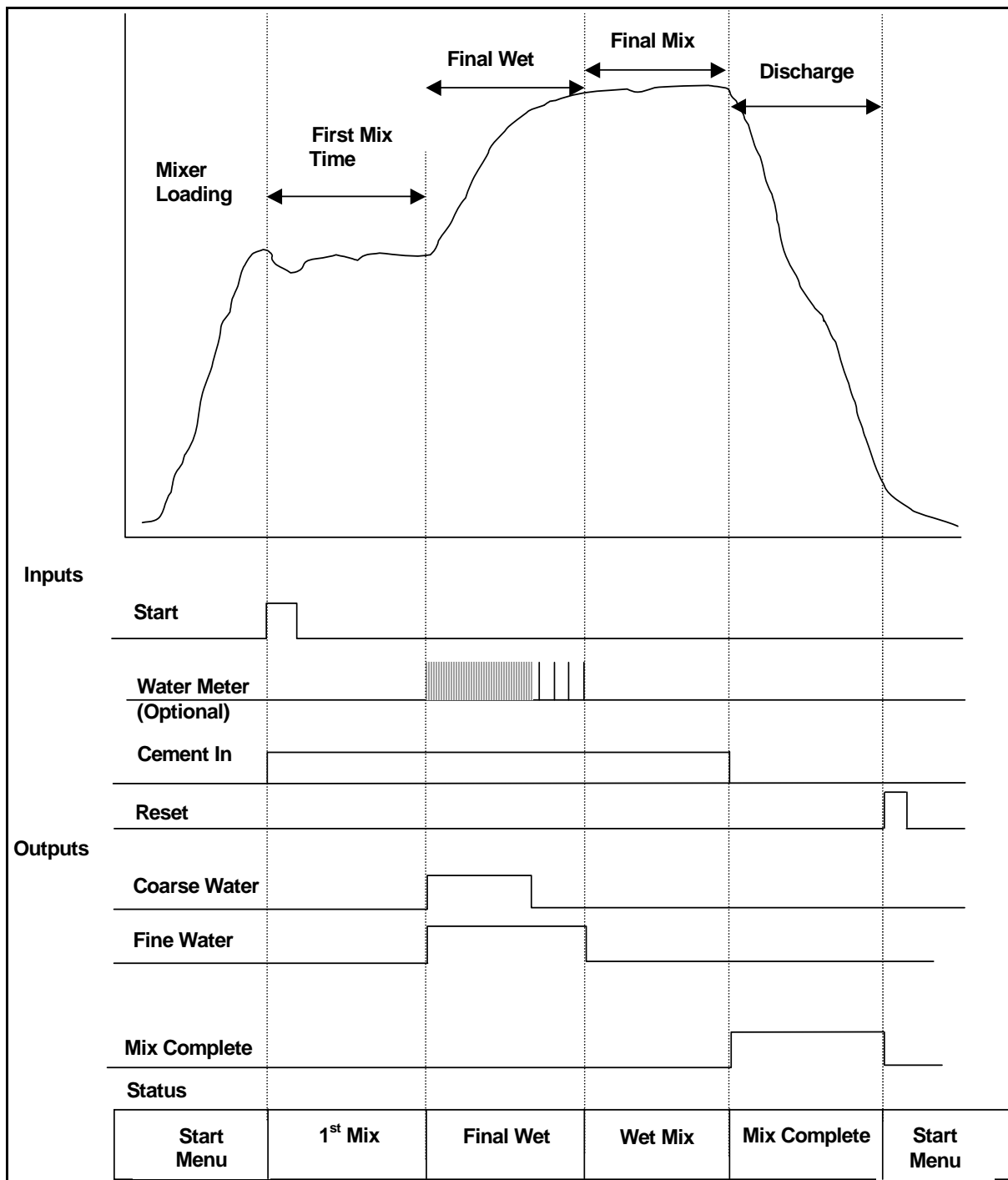

Figure 34 – Dry Mix Cycle (no Pre-Wet)

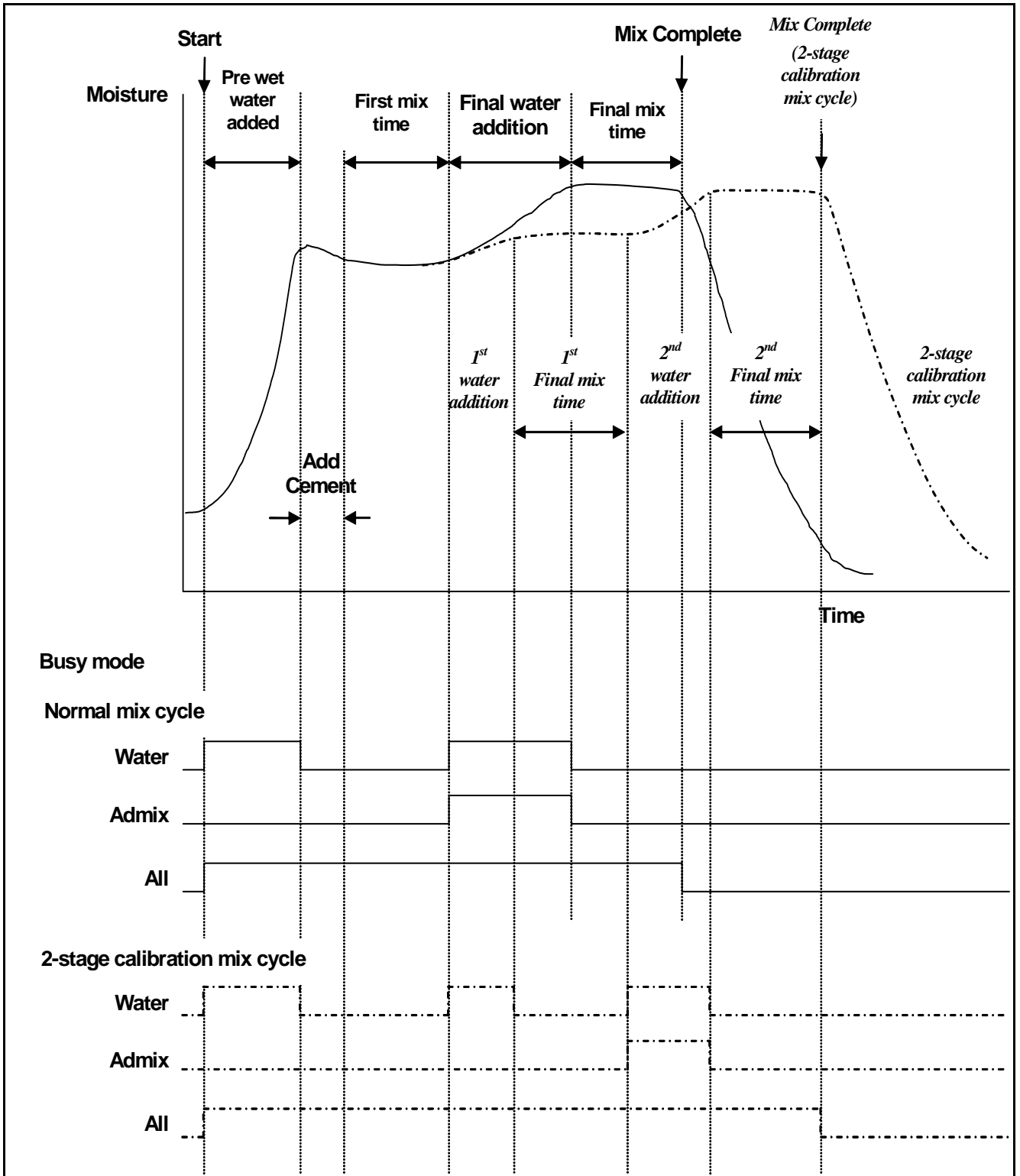

Figure 35 – Busy Signal

Explanation of mix cycle

The mix cycle (see previous figures) can have the following phases:

START MENU

System is waiting for **START** signal. The mixer will normally be running, and the aggregates will often be loaded or discharged with the Hydro-Control V at the **Start Menu**.

PRE-WET (if required)

Following the addition of aggregates, a **START** input (either by pressing the front panel button or by the plant computer sending the input high) will cause the system to add the amount of water defined in the recipe to the mixer before the cement is added. The mix cycle will continue after the time defined by the **pre-wet delay**. If no pre-wet is required the **Pre-wet water** and **Pre-wet target** should be set to zero. This will ensure that a 'dry mix cycle' will be completed.

CEMENT CALL (if required)

System will output a **PRE-WET DONE** signal indicating the Pre-wet is complete. This signal can be used to initiate the addition of cement. This phase terminates when either the **CEMENT IN** input is received, or the system exceeds the maximum permitted waiting time for the **CEMENT IN** signal. To avoid ambiguity, the **CEMENT IN** signal may stay high until the Hydro-Control V issues a **MIX COMPLETE**.

FIRST MIX

Time allowed for aggregates and cement to blend before entering controlled water addition. This is defined in the recipe menu.

FINAL WET

Time during which the system will control the water addition to achieve the target moisture value.

FINAL MIX

Time allowed for mix to achieve a homogeneous state following all water addition.

MIX COMPLETE

If at the end of the wet mix, the Hydro-Control V outputs a **MIX COMPLETE** signal, which may be used to initiate a discharge sequence.

START MENU

After the **RESET** input (either by pressing the front panel button or by the plant computer sending the input high) the **MIX COMPLETE** signal is cancelled and the system goes back to the **Start Menu**. The mix cycle will start as soon as another **START** input is received.

Input and Output Functions

Inputs

START/RESUME

Minimum 200mS pulse used to initiate the next mix cycle or to resume current mix cycle following a pause. Event occurs on leading edge of pulse.

CEMENT IN

Minimum 200mS pulse to indicate that cement addition to the mixer is complete. Event occurs on leading edge of pulse.

PAUSE/RESET

Minimum 200mS pulse used to place the unit in a ready state for the next batch and remove the **MIX COMPLETE** signal. Can also be used to pause the current mix cycle. Event occurs on leading edge of pulse.

WATER METER

Maximum 50 Hz input used for counting the amount of water added. **Water mode**, **Meter flow/pulse** and **Meter timeout** are used for setting up the water meter input. Count occurs on leading edge of pulse.

Outputs

COARSE WATER

Output used to switch on the coarse valve. Maintained high while coarse water required.

FINE WATER

Output used to switch on the fine valve. Maintained high while fine water required.

BUSY

Output used to signal that the system is busy, either (i) during only the Pre-wet and Final wet phases of the mix cycle, (ii) during the final water addition phase only (for use with admix) or (iii) throughout the whole mix sequence, selectable by **Busy mode** (see System Settings).

PREWET DONE

Output used to signal that the Pre-wet phase (**Pre-wet water** addition and **Pre-wet delay**) has completed. Maintained high until **CEMENT IN** received. If **Cement timeout** is set to zero then this pulse will be momentary.

MIX COMPLETE

Output to indicate that the unit has completed the current batch mix cycle. Maintained high until **RESET** input received.

ALARM

Output to indicate that the unit has entered an **ALARM** condition. Intervention is normally required to clear the alarm.

Basic Tests

Sensor Testing:

The Hydro-Control V uses a RS485 serial communications interface to communicate with the Hydronix moisture sensor. Once the sensor has been connected, the Hydro-Control V can be switched on. The Hydro-Control V will show a start-up screen displaying the Firmware version for approximately 3 seconds. After this period the **Start Menu** will be displayed and will search for the sensor. A message in the 'Moisture' display box will show **Polling** until the sensor is located. If the current control mode is **Auto** the main display area will also show:

ALARM!

No response

from sensor nn

Where nn is the address the Hydro-Control V is currently searching.

After a maximum of 15 seconds the display sensor should be located and the display will change to the standard **Start Menu** (– see section **Start Menu**), displaying the current moisture value and the trend display.

1. Press **<More...>** (F5) and then **<Setup>** (F1) to access the **Setup System** menu.
2. Enter the **Advanced password** (see Appendix D), press **<Diag>** (F2) followed by **<Mon>** (F3) to display the **Monitor** page that shows the unscaled values being read from the sensor.
3. With the mixer empty and the sensor clean and dry, the unscaled value shown should read close to zero (0). Due to differences in installation the empty value may vary and acceptable values will be in the range 0 to 14.
4. Get someone to place the palm of their hand on the sensor; the unscaled value should now climb to a value of 70 - 85 over a period of approximately 30 seconds. The value does not reach the final value instantly due to the rate limiting and smoothing filters in the sensor.

The above verifies that the sensor is working correctly and that the communications with the sensor is also working correctly.

Press **<Back>** (F5) three times to return to the **Start Menu**.

Valve Testing:

1. From the **Start Menu** press **<More...>** (F5) and then **<Setup>** (F1) to access the **Setup System** menu.
2. Enter the **Advanced password** (see Appendix D).
3. Press **<Test>** (F4) to display the **Test** menu
4. Press **<Valve>** (F2) to display the **Checking valves** menu.
5. Press **<Reset>** (F1) to reset the display.
6. Press **<Fine>** (F2) and keep pressed to ensure the fine valve activates correctly.
7. Press **<Reset>** (F1) to reset the display and repeat using **<Coarse>** (F4) to check the coarse valve.

Water Meter Testing:

The water meter function is most easily tested by using a 'dummy' recipe to deliver a set amount of water. The actual amount of water delivered can then be checked against the amount displayed.

The system parameters **Water mode**, **Meter flow/pulse** and **Meter timeout** must be correctly set before performing any meter testing – see section **Edit System Parameters**.

Arrange for the water delivered from both the coarse and fine valves to be diverted into a suitable container so that the actual amount of water delivered can be determined.

1. From the **Start Menu** press **<Recipe>** (F2)
2. Select a recipe for the dummy recipe
3. Set the **Pre-wet water** parameter to zero.
4. Enter the amount of water to be delivered in **Preset Final** parameter.
5. Enter a time in **First mix time** that will allow you to reach the water delivery point.
6. Check the **Water limit** parameter on page two of the recipe is greater than the **Preset Final**
7. Press **<Back>** (F5) followed by  to save the changes to the recipe.
8. Press **<Back>** (F5) again to return to the **Start Menu**.
9. Press **<Mode>** (F3) until **Preset** is displayed under Recipe number.
10. Press **<Start>** (F1), to start the dummy recipe; you will now have the amount of time defined by the **First mix time** to reach the area where the water is delivered to check the delivery.
11. After the water turns off, check the water amount shown on the display is consistent with the amount of water delivered.

The amount of water delivered and shown on the display ideally should be exactly the same as that requested by the **Preset Final** parameter. In most installations this will not be the case, as some water will continue to flow after the valves have been switched off. The **Fine Delivery** and **In-flight** parameters can now be adjusted to optimise the accuracy of the delivery – see section **Edit Control Parameters**.

After the water meter has been calibrated the flow rate of the fine and coarse valves may be checked from the **Checking valves** menu by pressing **<Fine>** (F2) or **<Coarse>** (F4) and dividing the amount of water displayed by the amount of seconds displayed. See Chapter **Valves and Water Flow Rates** for guidelines.

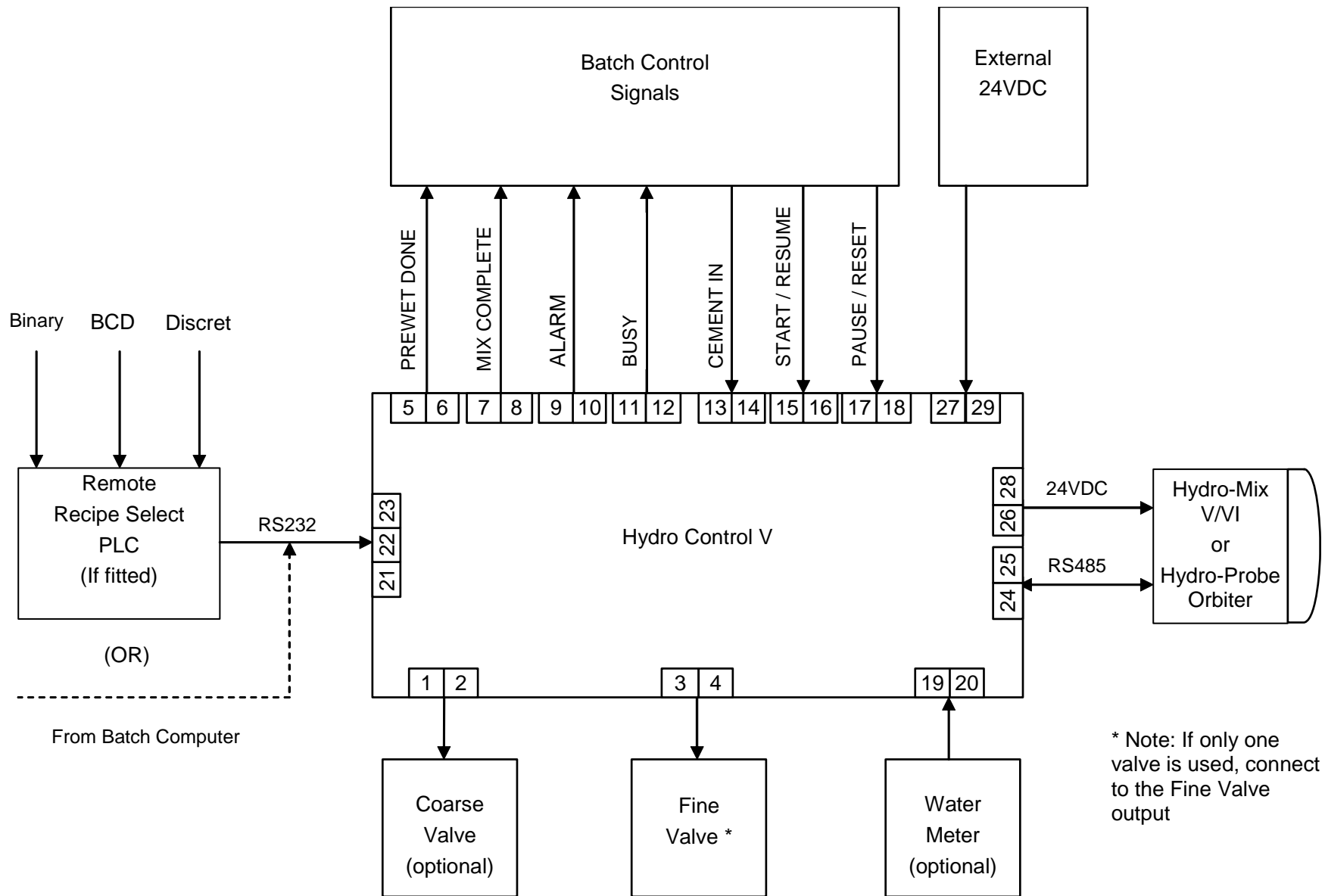

Figure 36 – System Block Diagram

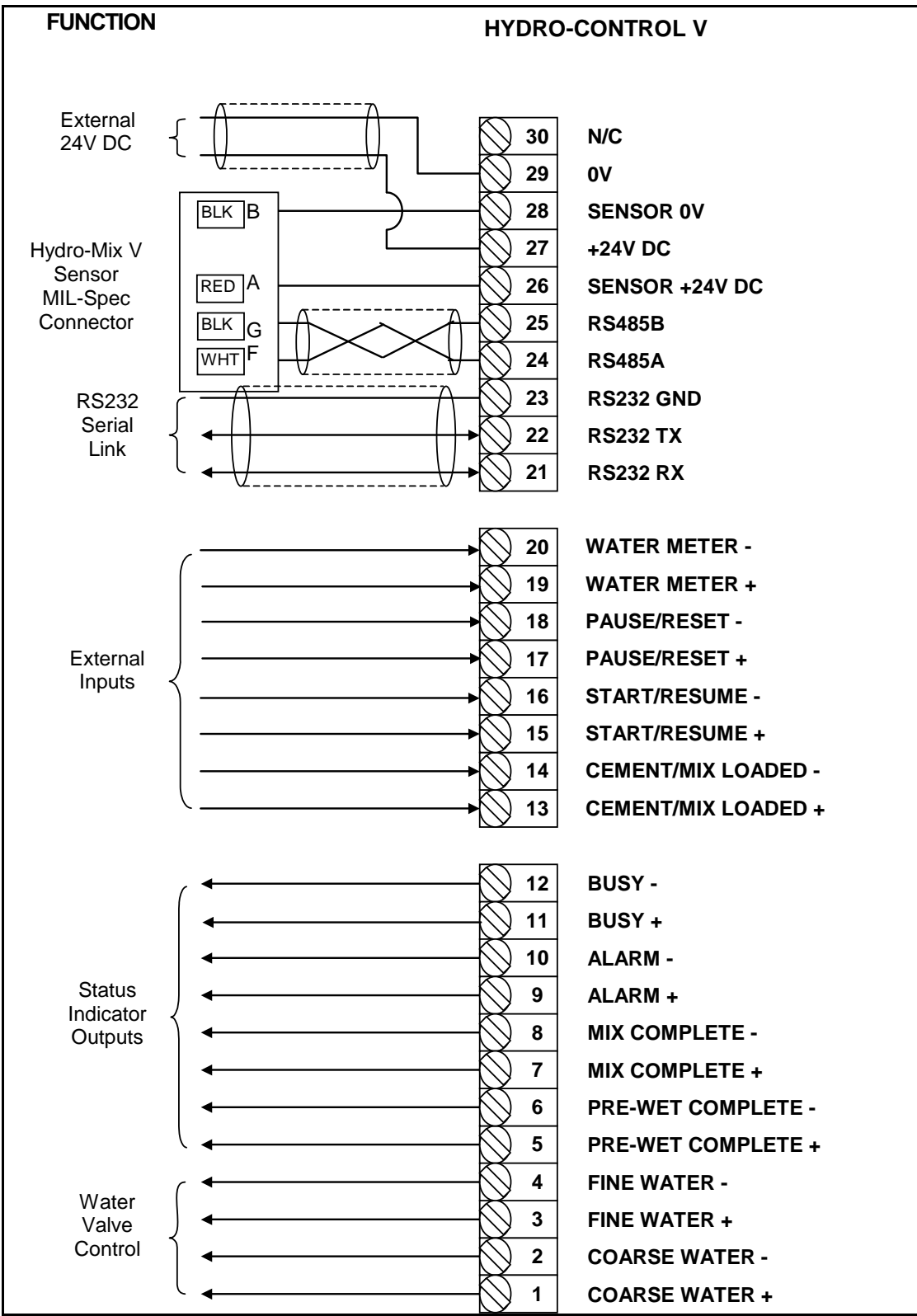

Figure 37 – System Interconnection

Note: The sensor cable screen is connected on Pin H of the Mil Spec connector ONLY.

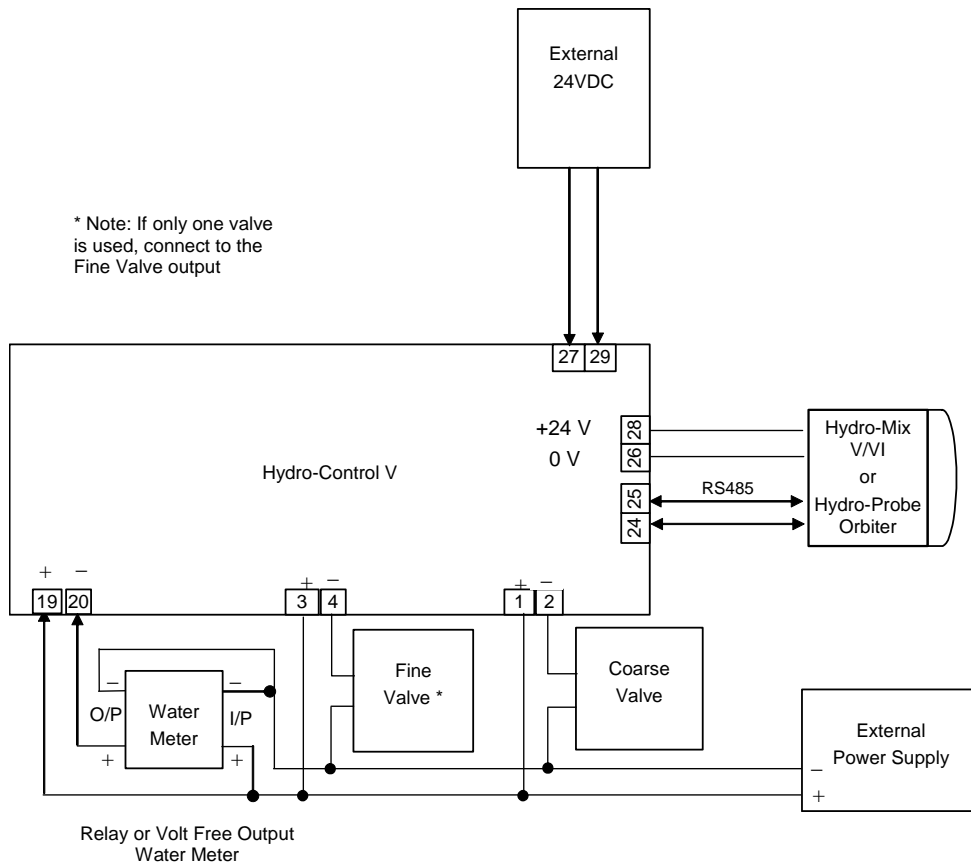

Figure 38 – Example Wiring Schematic For Manual Plant Operation

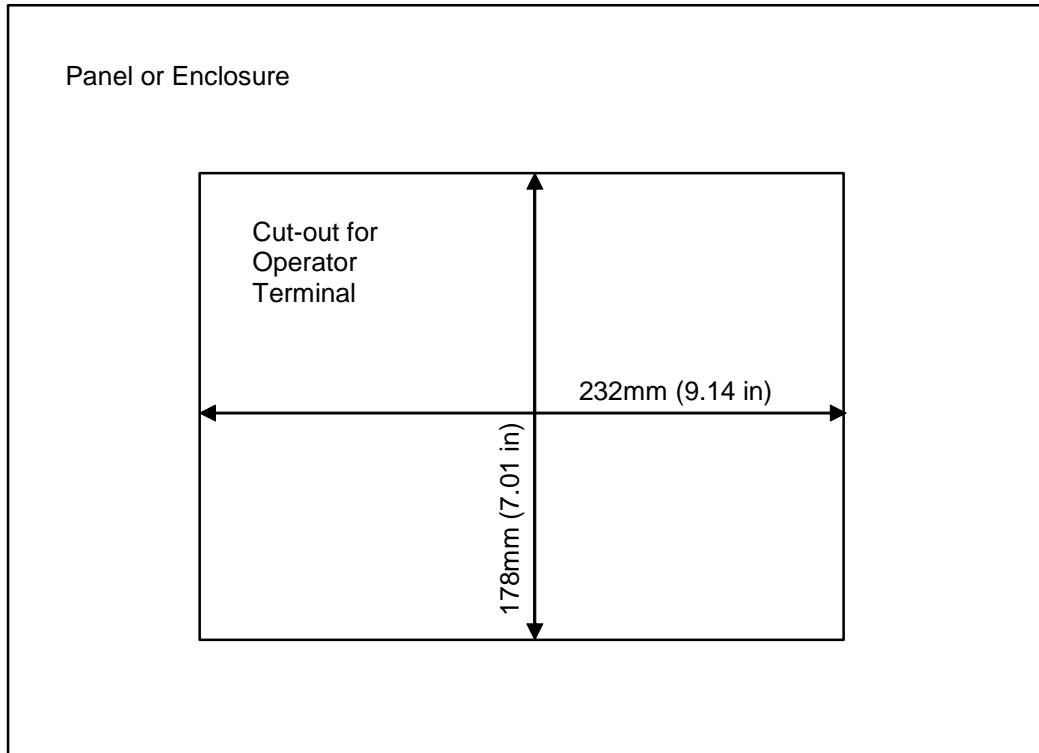

Figure 39 – Panel cut-out for Operator Terminal

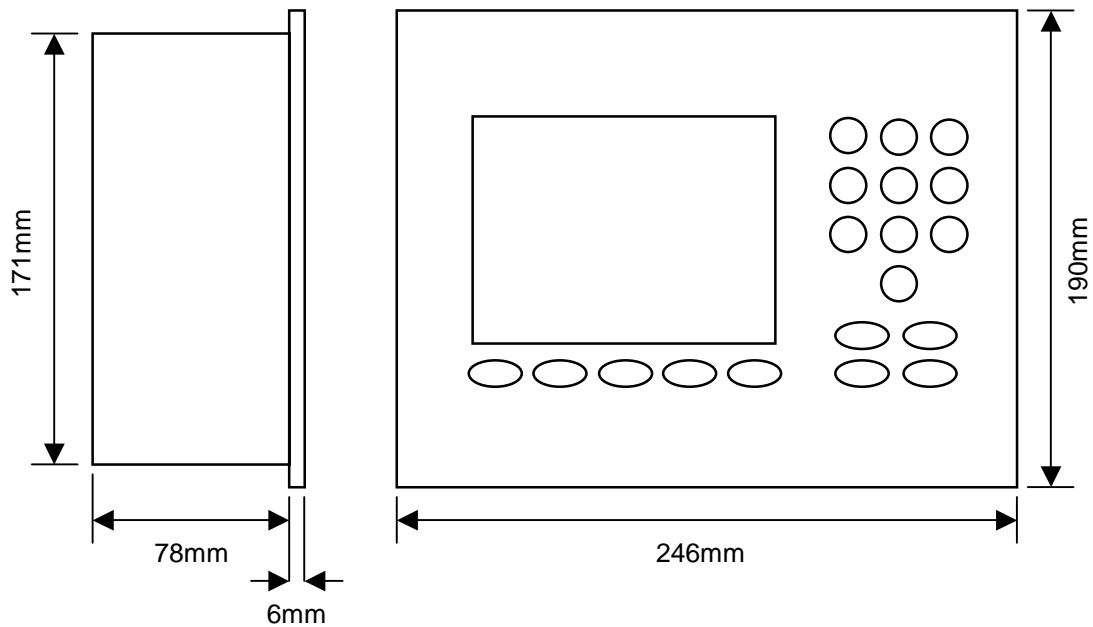

Figure 40 – Operator Panel Dimensions

Remote Selection via PLC

If the Hydronix supplied PLC (Hydronix part number 8102) is used for remote recipe selection the inputs to the PLC can be represented in one of three ways:

- **BCD:** The recipe number is applied in Binary Coded Decimal form. This allows all recipes 1 through 99 to be selected using eight inputs.
- **BINARY:** The recipe number is applied in Binary form. This allows all recipes 1 through 99 to be selected using seven inputs.
- **DISCRETE:** Each input allows one recipe to be selected, allowing recipes 1 through 10 to be used.

The selection method is configured by the state of inputs A and B on the PLC as defined in the table below:

Input A	Input B	Method
OFF	OFF	Discrete
ON	OFF	BCD
OFF	ON	Binary
ON	ON	Not Used

Note: There has to be a recipe in the Hydro-Control V to be able to select it. If there is no recipe, the selection remains as the last one selected.

Connecting the Hydronix supplied PLC for remote recipe selection

The 9 pin connector on the 'IMO K-7' PLC user port uses a different pin-out to a standard RS232 connector, and the Hydro-Control V must be connected to it according to the following diagram:

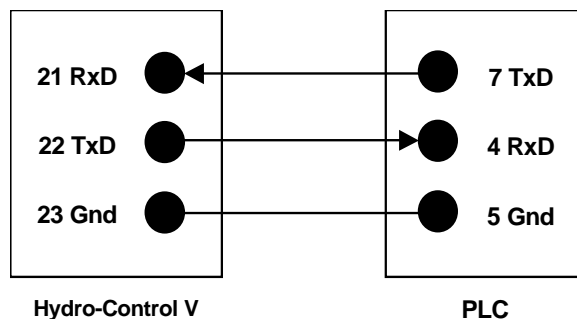

The PLC software is programmed to send a Recipe Select command via the RS232 port after the input selection is made: the input selection must change from zero to the desired selection code (according to the coding method as above: BCD, Binary or Discrete) for more than 200ms, then return to the Zero state.

Additionally, the PLC will operate relay output P47 after a Recipe Select command – the Hydro-Control V requires that Recipe Selection is made during **Start menu** only, this output may be used to delay the **START** signal to the Hydro-Control V in case the Recipe Selection is made at the same instant as the plant Start signal in order to ensure the selection is registered.

The relay output P47 may also be used to originate a **START** signal upon receipt of a Select Recipe command. For example, different remote plant stations may invoke a **START** signal simply by sending a Recipe Select, which may be unique to each station. The batching plant must still load the mixer, of course.

The following figure shows connections to the IMO-K7 PLC terminals.

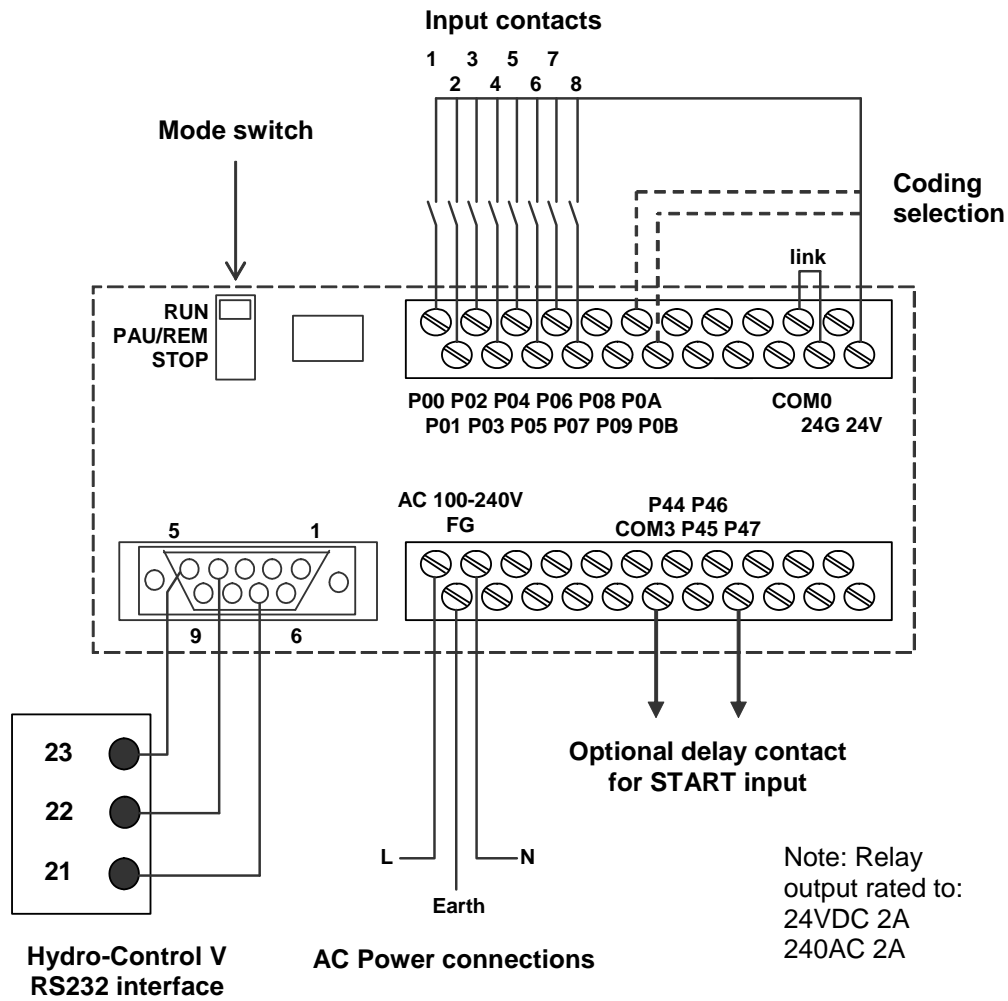

Figure 41 – Remote Recipe PLC Connections

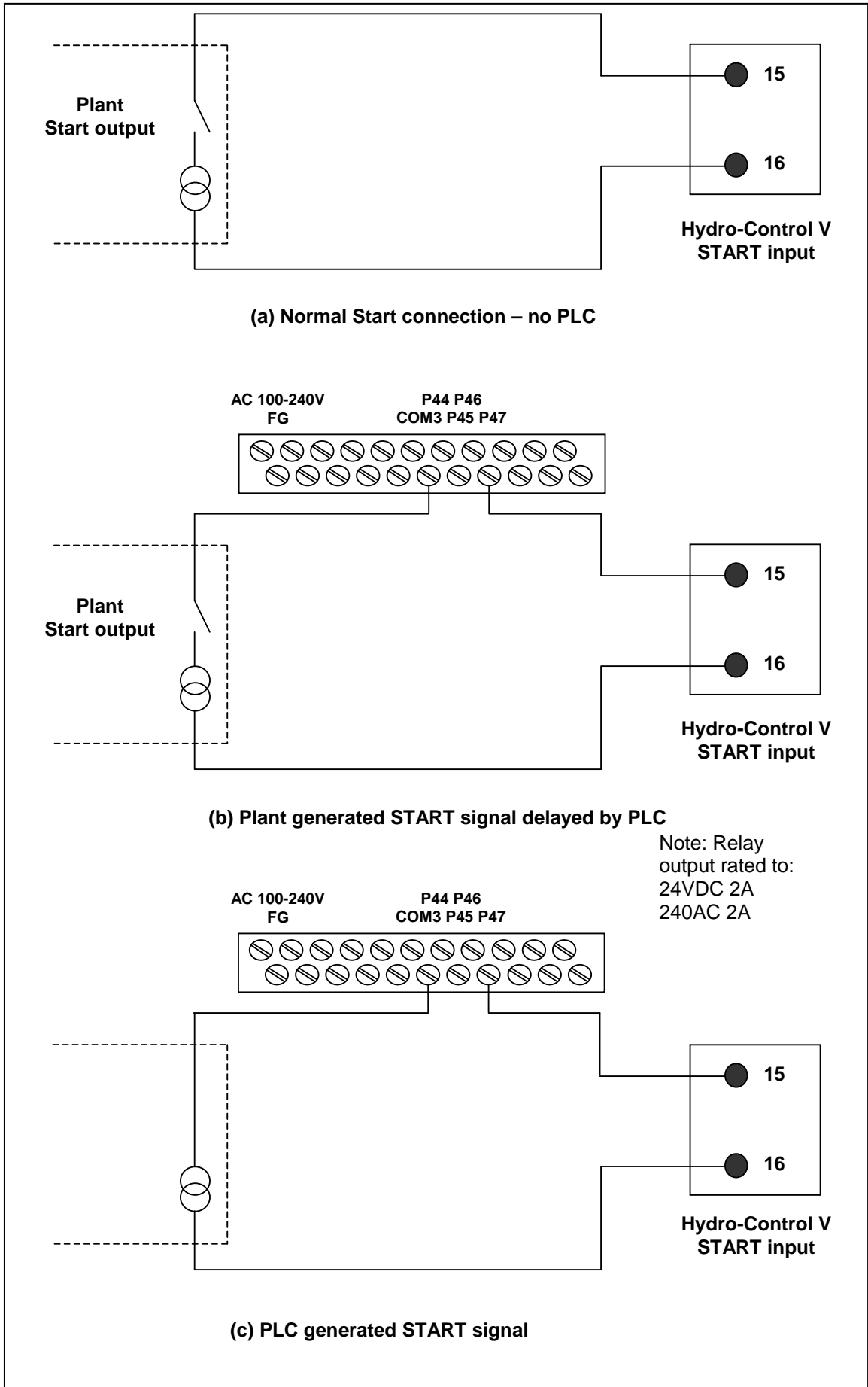

Figure 42 – Remote Recipe PLC Start Signal Options

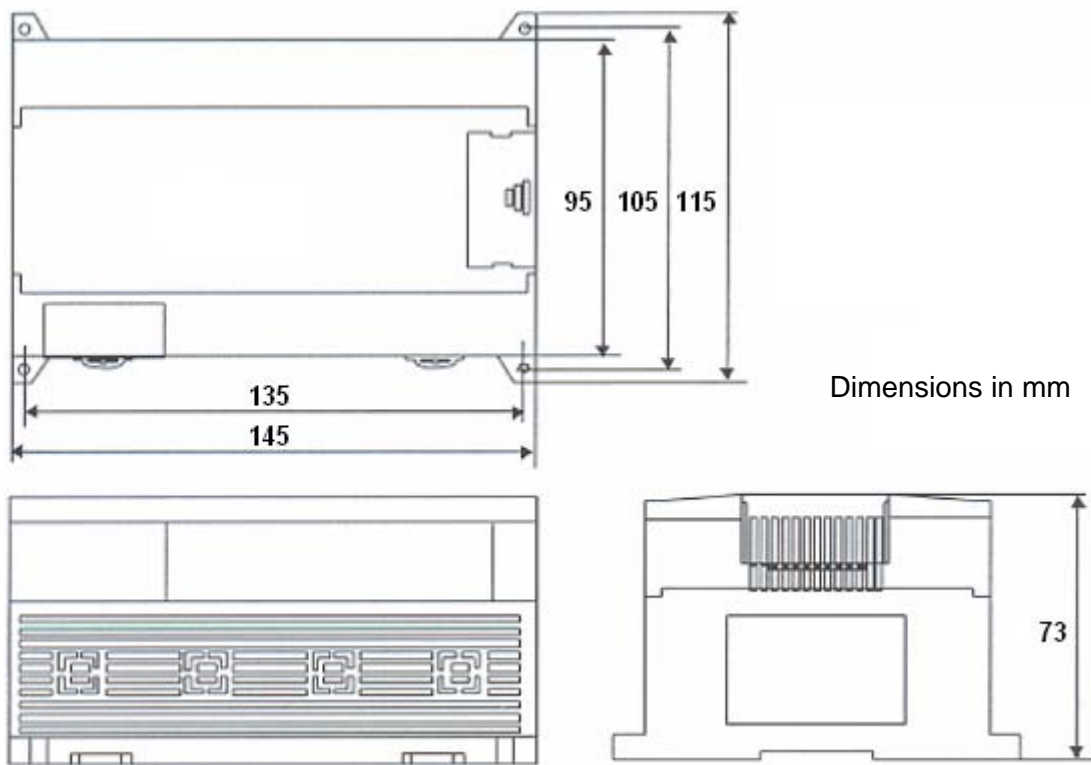

Figure 43 – Remote Recipe PLC Dimensions

Chapter 6 Valves and Water Flow Rates

While the Hydro-Control V can work with a single water control valve, optimum performance (fastest cycle times with least overshoot) will probably only be achieved with:

- A coarse valve to rapidly bring the moisture level near to target
- A fine valve to trim up the moisture level to the target without overshoot

It is essential that the valves are correctly sized and flow rates correctly adjusted with respect to the mixer capacity and efficiency.

Valves should be able to turn on and off rapidly – the combined on/off cycle time for a 50 mm (2") valve should be no more than 2 seconds and 19 mm (3/4") valves should have combined on/off cycle time of no more than 1 second. This permits precise water addition.

Example:

Metric units:

If a 1m³ mixer has only a coarse valve with a water flow rate through the valve is 10 L/s and an on/off cycle time of 1 sec, then water can only be added in 10 L steps. With a full load (~ 2200 Kg) then the smallest moisture step is approx. 0.5%, which is too coarse for adequate control.

If the same system was also fitted with a fine valve which had a flow rate of 1 L/sec and an on/off time of 1 sec, then using this valve would permit water addition in steps of approx. 1 L or 0.05% giving good control.

US units:

If a 35ft³ mixer has only a coarse valve with a water flow rate through the valve is 3 Gal/s and an on/off cycle time of 1 sec, then water can only be added in 3 Gal steps. With a full load (~ 4800 lbs) then the smallest moisture step is approx. 0.5%, which is too coarse for adequate control.

If the same system was also fitted with a fine valve, which had a flow rate of 0.3Gal/sec and an on/off time of 1 sec, then using this valve would permit water addition in steps of approx. 0.3Gal or 0.05% giving good control.

It is worth noting that a higher water flow rate should normally allow a shorter mix cycle time for an efficient mixer, provided the valve is fast enough to control the dose (on/off time is short). A slow flow rate and slow valve will provide the same dosing accuracy but will take longer to complete a mix.

Guidelines For Sizing Valves & Flow Rates

- **Fine valve flow rate** multiplied by on/off cycle time should be in the range 0.04% to 0.1% moisture increase (e.g. into 1m³ {35ft³} mixer, flow rate x on/off time should be in the range 1 to 2.4L {0.26 to 0.63Gal})
- **Coarse valve flow** rate multiplied by on/off cycle time should be in the range 0.25% to 0.5% moisture increase (e.g. into 1m³ {35ft³} mixer, flow rate x on/off time should be in the range 6 to 12L {1.6 to 3.2Gal}))
- **Valve on/off time** if in doubt, set it to one second, then choose valve sizes to give suitable flow rate according to the chart below
- **Valve Cycle Time** should be at least twice the Valve On/Off Time, with a minimum cycle time of 3 seconds recommended.

Mixer Capacity (m3)	Load (Kg)	Coarse valve			Fine valve		
		Flow rate (L/sec)	On/Off Time (sec)	% Moist Increase	Flow rate (L/sec)	On/Off Time (sec)	% Moist Increase
0.25	550	2	1	0.36	0.4	1	0.07
0.5	1100	4	1	0.36	0.75	1	0.07
1.0	2200	8	1	0.36	1.5	1	0.07
1.5	3300	12	1	0.36	2.25	1	0.07
2.0	4400	15	1	0.34	3	1	0.07

Mixer Capacity (ft ³)	Load (lbs)	Coarse valve			Fine valve		
		Flow rate (Gal/sec)	On/Off Time (sec)	% Moist Increase	Flow rate (Gal/sec)	On/Off Time (sec)	% Moist Increase
10	1400	0.6	1	0.36	0.1	1	0.06
20	2800	1.2	1	0.36	0.25	1	0.07
40	5500	2.4	1	0.36	0.5	1	0.07
60	8300	3.6	1	0.36	0.75	1	0.07
80	11000	4.5	1	0.34	0.9	1	0.07

Supply Voltage

24V DC 11W nominal power for Hydro-Control V and sensor

Recommended supply 24 V DC, 1A minimum (24W).

Important: If using 24V DC for inputs/outputs (valves etc), use a separate 24V DC supply to that powering the Hydro-Control V.

NOTE: The power cable must be screened and the screen connected at the earth stud on the Operator Terminal only.

Keyboard

Sheet keyboard with polyester overlay.

Graphical Display

120 mm x 90 mm (4.75" x 3.55") ¼ VGA display with backlight

Security

Open access for operators. Critical operations protected by two levels of pass codes (supervisor & engineer level).

Connections

Sensor cable

Two pairs twisted (4 cores total) screened (shielded) cable with 22 AWG, 0.35mm² conductors.

Screen (shield): Braid with 65%minimum coverage plus aluminium/polyester foil

Recommended cable types: Belden 8302, Alpha 6373

Maximum cable run: 100m, separate to any heavy equipment power cables.

Interface Modules

Six output modules and four input modules are provided as standard.

For voltage options refer to **Installation**.

At least the **FINE WATER** output must be connected. All other connections are optional and can be connected as appropriate for each configuration.

Communications

RS232

For connection to batch computer, remote recipe module or remote operator terminal to permit the remote selection of recipes. System Software can also be upgraded by connecting a PC to the RS232 port.

RS485

For communicating with the Hydronix moisture sensor, including changing operating parameters and sensor diagnostics. Simulator program also uses RS485 communications.

Operating Temperature Range

0 – 50 °C (32 °F – 122 °F)

Electromagnetic Compatibility

Meets the requirements of Electromagnetic Compatibility Directive 89/336/EEC

Mechanical

Dimensions

Fascia: 190 mm (H) x 246 mm (W); (7.48" (H) x 9.69" (W))

Panel Cut out: 178 mm (H) x 232 mm (W); (7.00" (H) x 9.14" (W))

Max Panel Thickness: 12 mm

Depth: 84 mm (3.54")

Depth behind Fascia: 78 mm (3.31")

Weight: 2.15 Kg (4.75 lb)

Protection: Front panel protected to IP65

Appendix A Advanced Control Parameters

Edit Control		Rec./Batch
System mode : Normal		1 / 3
Coarse/upper thr : 0.8		Pre-set
Derivative/gain : 1.0		Moisture
Cycle/on-off : 3.0		---.---
RS232 mode : Plant		
Samples -s : 0.1		
Cycle Loops : 0		
Address : 0	<	Run Time
		-- 5
Status:		
Inc	Dec	Back

Figure 44 – Edit Advanced Control Parameters Screen

The **Advanced Control Parameters** are only used by the **Auto** mode mix cycle control.

To access the **Advanced Control Parameters** the '**Hydronix**' password must be entered at the System Setup menu (see section **Setup System**). Enter the edit system control parameters menu by pressing **<Control>** (F3) and move the cursor (<) down to '**More...**' at the bottom of the menu.

Advanced Control Parameters

Parameter	Units	Default	Range
System Mode	None	Normal	Normal, Test
Coarse/upper thr.	None	0.8	0.0 – 1.0
Derivative/gain	None	1.0	0.0 – 10.0
Cycle/on-off	None	3.0	0.0 – 10.0
RS232 Mode	None	Plant	Plant, Screen
Samples	Seconds	0.1	0.1 – 9.9
Cycle Loops	None	0	0-99
Address	None	0	0-16

System Mode: This can be set to one of two modes:

- Normal – displays normal operating information only.
- Test – setting this mode will display the internal control variables on the screen. These are:
 - Average unscaled reading during dry mix averaging time
 - Unscaled deviation (max-min readings) during the dry mix averaging time
 - Average unscaled reading during wet mix
 - Unscaled deviation (max-min readings) during the wet mix averaging time
 - Number of water pulses received
 - Sensors unscaled reading

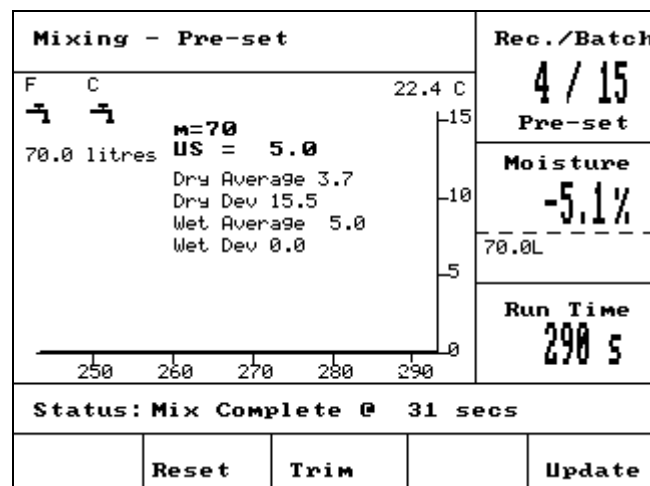

Figure 45 – Test mode screen

Coarse/upper threshold ratio - together with the **Upper control threshold**, this ratio defines the point at what the coarse valve is no longer used. A lower value will keep the **COARSE WATER** output on for longer, switching the **FINE WATER** output on closer to the **Moisture target**.

Derivative/gain - together with the **Gain**, this ratio defines the **Derivative gain**: This value attempts to compensate for how fast the moisture content is rising, and slows the water addition if the moisture content is rising rapidly.

Cycle/on-off – together with the **Valve on/off time** this ratio defines the **Valve cycle time**: This determines how *often* the valves are switched on and off. It should not be less than twice the On/Off time. A shorter time will be faster and give more precise control (if your mixer is fast enough to take advantage of it) but will cycle the valves more often, which could lead to wear.

RS232 mode: Determines how the serial port may be used:

- Plant – RS232 communications with plant control.
- Screen – allows screen dump of display bitmap.

Samples: The number of seconds over which the readings from the sensor will be averaged to provide the moisture reading. The Hydro-Control V reads the moisture from the sensor 5 times per second during mix cycles.

Cycle Loops: Sets the number of times the Hydro-Control V will loop through the final-wet and final mix phases of the mix cycle. This is useful when performing linearity tests, where the same amount of water needs to be added in steps. As an example, if a linearity test is to be performed and the water is added in 5 stages, then the complete cycle would be (with no prewet):

Cycle Loops = 5

First Mix > Final Wet ¹> Final Mix ¹> Final Wet ²> Final Mix ²> Final Wet ³> Final Mix ³>
Final Wet ⁴> Final Mix ⁴> Final Wet ⁵> Final Mix ⁵

Address: Allows sensor selection when more than one sensor is connected via RS485. Setting this to zero enables the Hydro-Control V to communicate with all address numbers (1-16) whereas a non-zero number will make the Hydro-Control V only communicate with that specific sensor.

Auto mode

The **Auto** mode control algorithm the Hydro-Control V used in the **final wet phase** of the mix cycle is a modified Proportional/Differential (PD) algorithm. In these types of algorithm, the system first calculates the difference between the current value of moisture and the target value. This difference is used in two stages to define an output level, which can be considered as the percentage of time the water valves are open.

First, the difference is multiplied by the proportional gain. In this way as the current moisture value approaches the **Moisture target**, the output drops and the likelihood of over-shooting the target is reduced. A value of 20-40 is typical for moderate to good mixers. Slower acting mixers should use lower values.

Secondly the rate of increase or decrease of the difference is calculated. This is multiplied by the derivative gain and subtracted from the output level. This parameter makes a correction for how quickly the moisture level is rising, again in an attempt to prevent overshooting the target.

The overall output level is calculated and constrained to be a number between 0 and 100, with large numbers representing the valve(s) being on for a greater percentage of time and zero meaning the valve is off. In systems with both a coarse and a fine valve, if the output level is greater than a certain value (determined by **Coarse/upper thr.** in the **Advanced Control Parameters**) then water is added using both the coarse and the fine valves. If the output level is below this level only the fine valve is used.

Calc mode

Calc mode *calculates* the amount of water required to achieve a moisture target. In this way the user still achieves an accurate **Moisture target** but the water required is added in 'one shot' to the mixer.

Each recipe must first be **calibrated** (see Section **Calc Mode**). During a calibration mix cycle a fixed amount of water (the **Calib. water** for that recipe) is added to a mix during the **Final wet** phase. The system uses the **Dry weight** of the mix and the 'dry' and 'wet' values of moisture (the moisture at the end of the **First mix** and **Final mix** respectively) to calculate a calibration slope for that recipe (relating the change in moisture of the mix to the amount of water added). It is important to note that if additives are to be added to the mix these must be added **after** the calibration slope has been calculated. (To facilitate this water can be added to a calibration run in two stages - see Section **Calc Mode**). At the end of the mix **two** moisture targets are automatically defined for the recipe – the **Calc %** and **Moisture target**. The **Calc %** target is defined by the final moisture level generated by the **water addition only** and not by the effects of any mix additives. The **Calc %** target is used to calculate the amount of **water** to be added to each subsequent **Calc** mode mix cycle. The **Moisture target** is the final value of moisture reached at the end of the calibration run taking into account the moisture level generated by the water addition and any modifications to the moisture level generated by the addition of mix additives.

At the end of a calibration run the user will be prompted to enter a 'final target' value. This value will allow the **displayed final target** moisture to be defined. For example, after a calibration run the **final target** moisture reading might be 6.3%. If the user would prefer the final reading to be 8.0% then 8.0 should be entered when prompted. The **calculated** and **final target** moisture targets for that recipe will then be automatically amended **without altering the calibration**.

Notes:

Appendix C System and Control Parameters Record

System parameters

This section should be used to record the System setup parameters.

Parameter	Value
Water mode	
Meter flow/pulse	
Meter timeout	
Language	
Busy Mode	
Max. recipes	

Control parameters

This section should be used to record the System Control setup parameters.

Standard

Parameter	Value
Gain	
Upper Control Threshold	
Lower Control Threshold	
Valve on/off Time	
Fine delivery	
In flight	
Averaging Time	
Mix Extension	
Access mode	
Valve – Pre-wet	
Valve – Final-wet	

Advanced

Parameter	Value
System Mode	
Coarse/upper thr.	
Derivative/gain	
Cycle/on-off	
RS232 Mode	
Samples	
Cycle Loops	
Address	

Notes:

Operator password

Operators do not need a password.

Operators can:

- Start, stop, pause & abort the system
- Create, select & edit recipes

Supervisor password

Supervisors can:

- Do everything operators can do
- Access the top page of the system menu (water meter settings, timeouts, supervisor password etc.)
- Access the system diagnostics

Advanced and Hydronix passwords

The **advanced** and **Hydronix** passwords, which permit access to the Hydro-Control V control and advanced control parameters respectively, are programmed into the Hydro-Control V firmware and **cannot be changed**. If the passwords become known to unauthorised people, those people will have access to the system control parameters, which if incorrectly set could make the system unstable. Therefore these passwords should not be released.

The passwords are printed separately on the next page and can be removed to protect system security.

Intentionally Blank

Advanced password

The advanced password (used to access the control parameters and valve test function) is **3737**.

Hydronix password

The Hydronix password (used to access the advanced control parameters) is **0336**.

NOTE: You may wish to remove this page from the book to prevent unauthorised use of these passwords.

Intentionally Blank

Reduce your mix cycle time ...

By optimising the performance of your mixer.

The speed with which any water control system can work is very much dependent on the time taken to obtain a meaningful reading. The moisture reading from the sensor indicates what is happening in the mixer. The speed of reading, or the time taken to reach a steady reading when the materials are homogenous reflects the effectiveness of the mixer. By taking some simple precautions, the overall performance can be considerably improved and the cycle time reduced with consequent financial savings.

1. Adjustment of the blades

Ensure the mixer blades are regularly adjusted to comply with the manufacturers recommendations (normally 2mm clear of the floor), with the consequent benefits:

- All the residual mix is discharged when emptying the mix
- Mixing action close to the floor of the mixer is improved, thereby improving the reading of the sensor.
- Will reduce wear on mixer floor plates.

2. Plastic blades over sensor face

It is recommended that the blade or blades sweeping across the sensor face should be of the plastic synthetic type as this helps to keep the sensor clean and can sweep closer to the sensor with less risk of damage.

3. Cement addition

Mixing the fine cement particles in with the relatively coarse particular size of the sand and aggregates is a tough job. When possible, the cement addition should commence within a few seconds after the commencement of the addition of the sand and aggregates. Folding in the materials together in this way will greatly assist the mixing process.

4. Water addition

To facilitate the mixing action, the water should be sprayed in over as wide an area as possible, rather than discharged at one point. Remember excessively rapid water addition will increase the wet mix time required to reach homogeneity. Hence there is an optimum rate of water addition for achieving minimum mix cycle time.

Commencement of water addition should only start after the cement has been substantially mixed in with the aggregates.*

*Cement powder lying on the surface of the aggregates will absorb the water turning into a wet paste, which will be more difficult to disperse uniformly throughout the mix.

Notes:

Appendix F Diagnostics Record

Log of Diagnostics for Customer Support

A diagnostics utility is available from <http://www.hydronix.com/>. This utility uses the RS232 port to interrogate the Hydro-Control V (see section Connecting to a PC/Laptop) and saves diagnostic information that can be emailed to our Customer Support Staff.

If for any reason the Diagnostics utility cannot be used, please record the parameters and other details as indicated below. It is important that you have this information ready to fax when you are speaking to our Customer Support Staff.

UNIT SERIAL NUMBER (as found on the back plate of the Hydro-Control V)

PLANT PARAMETERS

Mixer type	i.e. Ribbon/Twin-shaft/Turbo/Planetary
Mixer Manufacturer	
Mixer size	
Normal Load	
Minimum load	
Normal dry moisture	

NOMINAL RECIPE VALUES

Pre-wet water	
First Mix Time	
Final Moisture %	
Final Mix Time	

SYSTEM PARAMETERS

Water mode	
Meter flow/pulse	
Meter timeout	
Setup password	
Language	
Busy Mode	
Max. recipes	

CONTROL PARAMETERS

(Standard and Advanced parameters)

Gain	
Upper Control Threshold	
Lower Control Threshold	
Valve on/off Time	
Fine delivery	
In-flight	
Averaging Time	
Mix Extension	
Access mode	
Valve – Pre-wet	
Valve – Final-wet	
System Mode	
Coarse/upper thr.	
Derivative/gain	
Cycle/on-off	
RS232 Mode	
Samples	
Cycle Loops	
Address	

Address	90	Diagnostics Menu	50, 52, 53
Alarm	33, 34, 37, 46	Displayed Moisture Value	34
Auto Mode	12, 14, 29, 32, 33, 38, 40	Dry Mix (First Mix) Cycle.....	71
Calibration.....	17	Dry Weight.....	34
Control Algorithm	93	Edit	
Autocal.....	51, 54	Recipe	31
Ave/Hold Delay.....	55	System	46
Averaging Time	49	Filtering Time	55
Batch Counter.....	34	Fine Delivery.....	49
Busy Mode.....	46, 74	Fine Water	74
Calc %	60, 61	First Mix	<i>See Dry Mix</i>
Calc Mode	12, 33	First Mix Time	33
Calibration.....	22, 93	Gain	20, 49
Calculation.....	38, 40	Hardware Menu	51
Calib Mode		Hydronix Password.....	99
Pre-Set.....	33	I/P 1	55
Start Menu	29	I/P 2	55
Calibration	41, 46	Input Module	69
2 Stage.....	24, 34	Inputs.....	74
Auto Mode.....	17	Interface Modules	87
Calc Mode.....	22, 93	Language.....	46
Hardware Menu	51	Lightning Strikes	68
Mix Control Modes	14	Lower Control Threshold ...	20, 49, 95, 104
Mix Log	43	Meter	
Mix Times.....	13	Flow / Pulse	46
Recipe.....	22	Timeout	46
Sensor Configuration	54	Minus Tolerance	34
Temperature Compensation	26	Mix Complete.....	73, 74
Trim and Update	38	Mix Cycle	73
Water	34	Control Method	36
Water Information	41	Resume.....	18
With Admix.....	24	Mix Extension	49, 95, 104
Without Admix.....	23	Mix Log.....	34, 39, 40
Calibration Type	34	Calibration.....	43
Cement Call.....	73	Downloading	58
Cement In.....	73, 74	Mix Sequence Diagrams	70
Cement Timeout.....	37	Mix Times	13
Coarse %.....	90	Mixer Status Commands	63
Coarse Water	74	Moisture Offset and Gain.....	34
Connecting Ancillary Equipment.....	69	Moisture Target	33
Control Algorithm.....	93	Monitor Menu.....	53
Control Method.....	28, 36, 40, 48	Output	
Cut Out	68	Module	69
Cycle Loops.....	90	Type	55
Deadband.....	32	Variable	55
Default Recipe Parameters	46	Outputs.....	74
Derivative Gain	90	Panel Cut-Out.....	80

Password	97	Setup Menu	
Pause/Reset	74	Diagnostics	50
Plus Tolerance	33	Hardware	51
Precautions	67	Monitor	53
Preset.....	32, 33, 34, 60, 61	Resonator	52
Final.....	33	Sizing Valves	86
Mode	12, 33	Slew Rate	
Pre-Wet.....	73	+ & -	55
Done.....	74	Stand By	73
Mix Cycle.....	70	Start Menu	28
Water.....	33	Auto Mode	28
Proportional Gain	49, 95, 104	Calc Mode	28
Recipe		Start/Resume	74
Default Parameters	46, 61	Status	9, 63
Edit	31	System	
Gain.....	33	Control Parameters	90
Parameters.....	32	Edit	46
Reading Parameters	60, 61, 63	Setup	45
Remote Selection	81	Temperature	
Selecting.....	30, 58	Compensation	26, 32, 34
Setting Parameters.....	59, 61	Start Menu	28
Remote Commands	57	Test	45
Remote Recipe Selection	81	Unpacking	67
Resonator Menu	52	Update	16, 18, 19, 23, 24, 36, 38
RS232	88	Upgrading Software	65
Connections	57	Upper Control Threshold....	20, 49, 95, 104
Port Settings.....	57	Valve	20, 45, 49, 62, 76, 86, 90, 95, 104
RS485	88	Cycle Time	90
Samples	90	On / Off Time	20, 49, 95, 104
Selecting Recipe	30, 58	Selection.....	49
Sensor Configuration	51	Ventilation	67
Sensor Cable	68	Water	
Sensor Calibration		Limit	34
Configuration	54	Mode	46
Hardware Menu.....	51	Trim	34
Sensor Configuration	50, 54	Wet Mix	73
Parameters.....	55	Wet Mix Time	33
Setup		Wiring Connections.....	68
System	45		