

# Hydro-Control IV Installation and Reference Guide

---

Hydronix part number: HD0044

Revision: 2.0

Revision Date: December 2000

---

## COPYRIGHT

Neither the whole or any part of the information contained in nor the product described in this documentation may be adapted or reproduced in any material form except with the prior written approval of Hydronix Limited hereinafter referred to as Hydronix.

© 2000      Hydronix Limited  
7, Riverside Business Centre  
Walnut Tree Close  
Guildford, Surrey  
GU1 4UG  
United Kingdom

All rights reserved

## CUSTOMER RESPONSIBILITY

The customer in applying the product described in this documentation accepts that the product is a programmable electronic system which is inherently complex and which may not be completely free of errors. In doing so the customer therefore undertakes responsibility to ensure that the product is properly installed commissioned operated and maintained by competent and suitably trained persons and in accordance with any instructions or safety precautions made available or good engineering practice and to thoroughly verify the use of the product in the particular application.

## ERRORS IN DOCUMENTATION

The product described in this documentation is subject to continuous development and improvement. All information of a technical nature and particulars of the product and its use including the information and particulars contained in this documentation are given by Hydronix in good faith.

Hydronix welcomes comments and suggestions relating to the product and this documentation.

This documentation is intended only to assist the reader in the use of the product and therefore Hydronix shall not be liable for any loss or damage howsoever arising from the use of information or particulars in or any error in or omission from this documentation.

## ACKNOWLEDGEMENTS

**Hydronix, Hydro-Probe, Hydro-Skid, Hydro-Mix, Hydro-View** and **Hydro-Control** are Registered Trade Marks of Hydronix Limited.

**OPTO-22** is a registered trademark of OPTO-22.

# About this manual

This manual describes the installation, commissioning and operation of the Hydro Control IV.

The day-to-day running of the system is described in a separate manual (reference: *Hydro Control IV Operators Manual HD0151 Rev 3.0*).

A brief description of the contents of each chapter in this manual is given below:

Chapter	Title	Contents
<i>Chapter 1</i>	<i>"Introduction"</i>	Brief introduction to the Hydro Control IV, its' principle of operation and hardware and software versions that currently apply.
<i>Chapter 2</i>	<i>"Operator terminal"</i>	How to use the front panel on the operator terminal and lists the keypad functions.
<i>Chapter 3</i>	<i>"Getting started"</i>	Quick reference guide to finding your way around the menus and performing some basic tasks including logging in/out of the system.
<i>Chapter 4</i>	<i>"Setting up a recipe"</i>	How to create, edit and copy recipes.
<i>Chapter 5</i>	<i>"Calibration"</i>	How to calibrate a recipe.
<i>Chapter 6</i>	<i>"Running the mix cycle"</i>	Describes the day to day running of the mix cycle including how to deal with alarms and how to abort a cycle.
<i>Chapter 7</i>	<i>"Configuration menus"</i>	Tables summarising the configuration menus with descriptions of every parameter in the menu.
<i>Chapter 8</i>	<i>"Display pages"</i>	Describes the various displays available and how they are used to monitor and analyse data from the mix cycle.
<i>Chapter 9</i>	<i>"Installation"</i>	How to install the Hydro Control IV system.
<i>Chapter 10</i>	<i>"System commissioning"</i>	How to commission the new system.
<i>Chapter 11</i>	<i>"Remote operation using RS232"</i>	How to connect the Hydro Control IV to a printer or batch controller for remote operation via an RS232 interface.
<i>Chapter 12</i>	<i>"Backup/Restore Utilities"</i>	How to set up your PC to use the Backup and Restore utilities available on the system.
<i>Chapter 13</i>	<i>"Maintenance"</i>	Includes information on replacement parts and general maintenance of the Hydro Control IV.

## *Appendices*

<i>A</i>	<i>Specification</i>	Technical specifications for the Hydro Control IV.
<i>B</i>	<i>Electromagnetic Compatibility</i>	EMC Conformance statement.
<i>C</i>	<i>Sequence Diagrams</i>	Basic automatic control and water sequence flow diagrams.
<i>D</i>	<i>Menu Map</i>	Expanded chart showing the access routes to each system menu.
<i>E</i>	<i>Basic Mix Cycle Timing</i>	Description of the basic mix cycle and its response to various input signals
<i>F</i>	<i>Troubleshooting</i>	Description of the factory test facility to check the functionality of the system
<i>G</i>	<i>System Commissioning Tables</i>	Record sheets for system parameters following commissioning of the Hydro Control Iv
<i>H</i>	<i>Installation/ Commissioning Checklists</i>	Record sheets for checking the correct installation of the system
<i>I</i>	<i>User Codes</i>	Access codes for the four levels of access to the system

Chapter 1	Introduction .....	12
1.1	Introduction .....	12
1.2	Principal of operation.....	13
1.3	Hardware version .....	13
1.4	Software version.....	13
1.5	Calibration .....	14
Chapter 2	Operator Terminal .....	15
2.1	Switching on .....	15
2.2	Adjusting the display contrast.....	15
2.3	Digipot .....	15
2.4	Keypad functions.....	16
2.5	Soft key functions .....	17
Chapter 3	Getting Started .....	19
3.1	Using the menus .....	19
3.2	Viewing display pages .....	20
3.3	Viewing a recipe .....	20
3.4	Adjusting values .....	21
3.5	Logging In/Out with the user code .....	22
Chapter 4	Setting up a recipe .....	24
4.1	Recipe database options .....	24
4.2	Creating/editing a new recipe.....	25
4.3	Copying a default recipe .....	27
Chapter 5	Calibration .....	28
5.1	Why calibrate? .....	28
5.2	Calibration methods .....	28
5.3	Preset mode .....	29
5.4	Two Point Water Addition Mode.....	32
5.5	Automatic Calibration Mode .....	34
5.6	Adjusting calibration values manually.....	35

5.7	Calibration problems.....	35
Chapter 6	Running the mix cycle .....	36
6.1	Starting the mix cycle .....	36
6.2	Choosing Manual Hold or Automatic Mode.....	37
6.3	Adjusting the scale of the trend display.....	38
6.4	Selecting the water addition method .....	38
6.5	Adjusting the pre-set water volume .....	39
6.6	Adjusting the calibration water volume.....	39
6.7	Trimming the water.....	40
6.8	Alarms .....	41
	Clearing/acknowledging alarms.....	41
	Configuring the alarms .....	41
6.9	Dealing with out of spec mixes .....	42
	Mix too dry.....	42
	Mix too wet .....	43
6.10	Aborting the current cycle .....	44
Chapter 7	Configuration Menus.....	45
7.1	Recipe database.....	45
7.2	Mixer control set-up .....	46
7.3	Mix log set-up.....	49
7.4	Sensor set-up.....	50
7.5	Water control set-up .....	51
7.6	Analogue output set-up .....	52
7.7	Alarms set-up.....	52
Chapter 8	Display Pages.....	54
8.1	Status display.....	54
	Current moisture value .....	54
	Trend display.....	54
	Mix cycle status.....	54
8.2	Data logging displays .....	55

Mix log display .....	55
Error trend display .....	56
Error distribution display.....	57
8.3    Diagnostic display pages .....	58
Sensor diagnostic.....	58
I/O diagnostic.....	58
RS485 diagnostic .....	58
RS232 diagnostic .....	59
Language translation check.....	59
8.4    Sensor capture display .....	60
Chapter 9    Installation .....	62
9.1    Unpacking the unit.....	62
9.2    Safety Instructions.....	62
9.3    Installing the operator terminal .....	64
Mounting in control panel.....	64
Connecting the power supply .....	64
9.4    Installing the wall-mounted enclosure.....	65
General layout .....	65
Wiring connections .....	65
9.5    Connecting the Hydro-mix sensor.....	69
Connections to panel mount operator terminal .....	69
Connections to wall-mount enclosure.....	70
Synchronisation input.....	71
9.6    Installing the Input/Output unit.....	72
Standard input/output unit.....	72
Remote recipe selection unit .....	72
Connecting the power supply .....	74
Connecting the I/O unit to the Operator terminal .....	74
Digital inputs configuration.....	75
Digital outputs configuration .....	75

Supported OPTO-22 input/output module types.....	76
Field wiring connections to standard input/output unit.....	77
Field wiring connections to remote recipe selection unit .....	78
Input/output unit switch settings.....	79
Relay outputs .....	79
9.7    Installation troubleshooting .....	79
Chapter 10    System commissioning .....	80
10.1    Select language and units.....	80
10.2    Check inputs/outputs.....	81
10.3    Check mixer control sequence .....	82
Remote recipe selection.....	82
RS232 interface to batch computer.....	82
10.4    Check water control sequence .....	83
Water mode.....	83
Water meter time-out.....	83
Fine delivery .....	83
Fine/coarse in-flight compensation values.....	84
Settling time.....	84
Valve leak alarm .....	84
Calibrate water weighing system.....	85
Water scale fill level .....	85
10.5    Run system in Preset mode.....	86
10.6    Filtering the sensor signal .....	87
Displaying the sensor signal .....	87
Filtering options.....	87
Signal processing examples .....	88
Recommended starting values for sensor set-up menu.....	92
10.7    Set up the Auto-track facility .....	93
Auto track deviation .....	93
Auto track time .....	93



Mix extension time.....	93
10.8 Set the mix tolerances.....	94
10.9 Run system in Automatic water mode .....	94
10.10 Record system configuration data.....	94
Chapter 11 Remote operation using RS232.....	95
11.1 RS232 connections on operator terminal .....	95
Connections at wall mounted enclosure.....	95
11.2 Null modem cable connections .....	96
11.3 Connecting a printer .....	97
11.4 Connecting a PLC / Batch controller.....	98
11.5 Remote operation using a PLC/batch controller .....	98
Setting up the Mixer Control Set-up.....	98
Sending remote commands .....	99
Replying to remote commands .....	104
Chapter 12 Backup / Restore Utilities.....	105
12.1 Hydro Control IV Backup/Restore Utilities.....	105
12.2 Connecting the PC .....	105
12.3 Downloading the utilities .....	106
12.4 Testing communication .....	106
To set up the Hyper Terminal program.....	106
To test the communications.....	106
12.5 Using the Backup/Restore utilities .....	107
To Backup .....	107
To Restore .....	108
To capture mix-log data .....	108
Chapter 13 Maintenance .....	109
13.1 Anti-static handling .....	109
13.2 EPROM replacement.....	109
13.3 Battery replacement .....	109
13.4 Fuses.....	110

Appendix A	Specification.....	111
Appendix B	Electromagnetic Compatibility .....	113
Appendix C	Sequence Diagrams.....	114
Appendix D	Menu Map .....	116
Appendix E	Basic mix cycle timing .....	117
Appendix F	Troubleshooting.....	119
Appendix G	System commissioning tables .....	121
Appendix H	Installation / commissioning checklists.....	123
Appendix I	User codes.....	126

## List of Figures

<i>Figure 1 - Hydro Control IV typical system Installation .....</i>	<i>12</i>
<i>Figure 2 - Hydro-Control IV showing the Status Display.....</i>	<i>15</i>
<i>Figure 3 - Keypad functions.....</i>	<i>16</i>
<i>Figure 4 - Soft key function.....</i>	<i>18</i>
<i>Figure 5 - Mains transformer .....</i>	<i>64</i>
<i>Figure 6 - Wall mounted enclosure dimensions.....</i>	<i>66</i>
<i>Figure 7 - Wall mounted enclosure back-plate .....</i>	<i>67</i>
<i>Figure 8 - Wall mounted enclosure wiring .....</i>	<i>68</i>
<i>Figure 9 - Sensor connections to panel mounted operator terminal.....</i>	<i>69</i>
<i>Figure 10 - Sensor connections at wall-mounted enclosure .....</i>	<i>70</i>
<i>Figure 11 - Input / Output unit general layout.....</i>	<i>73</i>
<i>Figure 12 - Input / Output unit connections via RS485 link.....</i>	<i>74</i>
<i>Figure 13 - Standard Input / Output unit field wiring.....</i>	<i>77</i>
<i>Figure 14 - Remote recipe unit field wiring .....</i>	<i>78</i>
<i>Figure 15 - RS232 connections at wall-mounted enclosure.....</i>	<i>95</i>
<i>Figure 16 - Null modem connections (9-pin).....</i>	<i>96</i>
<i>Figure 17 - Null modem connections (9-pin to 25-pin).....</i>	<i>96</i>
<i>Figure 18 - RS232 connections for printer .....</i>	<i>97</i>
<i>Figure 19 - RS232 connections for PLC / Batch controller.....</i>	<i>98</i>
<i>Figure 20 - RS232 connections for PC .....</i>	<i>105</i>
<i>Figure 21 - Operator terminal main circuit board .....</i>	<i>110</i>
<i>Figure 22 - Basic Mix Cycle Timing .....</i>	<i>117</i>
<i>Figure 23 - A more complicated mix cycle using the majority of Inputs and Outputs .....</i>	<i>118</i>
<i>Figure 24 - Wiring connections for factory test.....</i>	<i>119</i>

## 1.1 Introduction

The Hydro Control IV system from Hydronix is used in the concrete industry for completely controlling the mix cycle to provide precisely the correct addition of water in the shortest possible mixing time.

Using the reading from a single Hydro-Mix microwave sensor inside the mixer, the Hydro Control IV accurately monitors the percentage moisture throughout the mix cycle in both wet and dry mix periods. The correct amount of water is added based on pre-set recipes in order to achieve the required target for the percentage moisture.

The highest possible level of accuracy is achieved within a minimum mixing cycle time by means of unique signal processing techniques for reading the Hydro-Mix microwave sensor in the mixer.

The Hydro-Control IV system is the most technically advanced and easy to use unit on the market and is suitable for operating with new control systems or for fitting to existing plants.

The display provides a wide range of information via a series of menus including mixing cycle status, recipe information, sensor signal trend and error analysis in graphical form. New mix recipes can be calibrated at the push of a button.

The Hydro Control IV can also be connected to a printer or batch controller via an RS232 serial link as shown in a typical installation in Figure 1.

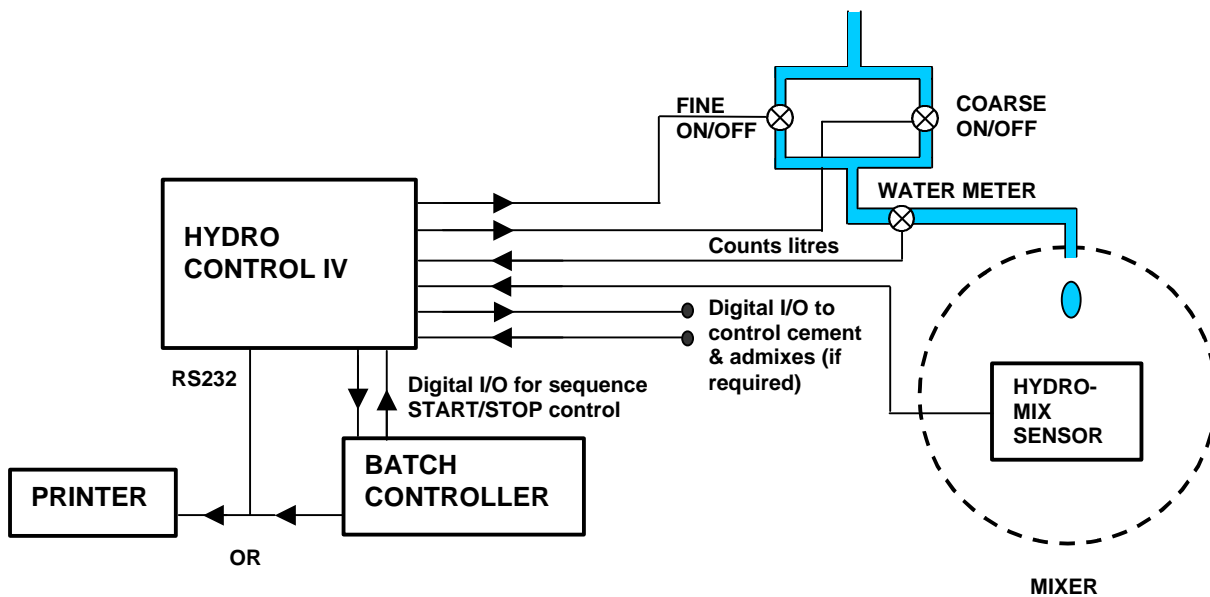

Figure 1 - Hydro Control IV typical system Installation

## 1.2 Principal of operation

The Hydromix sensor is placed in the mixture and radiates a microwave electromagnetic field of energy. Water molecules react to this field 100 times more than dry material. The sensor measures this absorbed energy and converts it into an electrical signal, which is input to the Hydro control IV, thus giving an accurate assessment of the quantity of water present in the material. Improvements in the HM05 sensor have extended the accuracy of these measurements to approximately 20% moisture content.

The advantage of this technique is that it minimises the effects of changes in density, particle size and temperature in the material.

The linear sensor output is converted to an exponential curve for use by the HCIV, with greater sensitivity being obtained at the dry end of the curve.

## 1.3 Hardware version

This manual refers to the following revisions of Hydro-Control IV system:

Operator Terminal:       Revision **D** onwards as indicated on the rear panel

Input/Output unit:       Revision **B** as indicated on the rating label

If your system pre-dates these revisions, please contact your Hydronix supplier for relevant earlier documentation.

Summaries of changes from the above revisions will be found in the relevant engineering notes available from Hydronix on request.

## 1.4 Software version

This manual applies to software versions **V3.02** and above as displayed on the start-up screen.

*A number of soft key functions and calibration routines have changed from previous versions of software and operators should read and understand the changes before operating the unit.*

The main changes to the software version **V3.02** from previous versions are as follows:

Polish Language

Polish language option added.

German Language

Minor corrections made.

Auto Track

The auto Track facility now has two sets of parameters allowing different limits to be set for the dry mix and wet mix cycles.

Remote recipe selection

Option added to select up to 4 recipes remotely using the digital inputs of the HC IV.

## Keypad function changes



Hand key renamed “Manual Hold”. Toggles between Manual Hold and Automatic.



Automatic key renamed “Water Addition”. Toggles between Automatic, Preset and Two Point Calibration modes of water addition.



Water trim key has added functionality when in Preset or Two Point Calibration mode. Allows the operator to set the pre-set water volume.



Calibration key has added functionality when in Two Point Calibration mode. Allows the Two point Calibration Water amount to be adjusted.

## 1.5 Calibration

Changes have been made to the calibration methods to improve performance of the system for wet cast products above 20% moisture content.

A “Two Point Calibration” method has been added to the water addition method. This simplifies the calibration process when the system is used in Wet Mix applications or when Admixes are used.

There are now three methods of calibration:

- **Automatic** for dry cast and block products **without** colour or additives. The user selects a “good mix” from the mix log for a batch that produced the correct product and presses the calibrate button. No other action is required.
- **Preset** for dry cast and block products **without** colour or additives. This is used when a **new recipe** is being configured for the first time to “teach” the HC IV the new mix design. It is also used as an emergency backup mode in the event of damage to the sensor. The system adds a set amount of water to the mix and records the effects of the water addition in the mix log. When the correct amount of water has been added, the “good mix” can be calibrated by selecting the batch record from the mix log and pressing the calibrate button. No other action is required. The Hydro-Control IV can then be set to run in Automatic.
- **Two Point Calibration** for dry cast and block products **with** colour or additives, where the HC IV admix 1 and/or 2 control signals are used, and **wet cast** with or without additives. This mode is essentially the same as Preset mode except the Hydro-Control IV adds the water in two amounts. The first water addition, Calibration water, is normally set at 50% of the Preset water but may be adjusted to any value up to the Preset water value. The second water addition is then calculated by the HC IV as the Preset water value minus the calibration water. Admixes, if used, will be added to the mix during the second water addition.

These methods are described in detail in *Chapter 5 “Calibration”*.

The following calibration items have been removed: -

- Multipoint calibration and graphical displays.
- Quadratic calibration
- Two Shot water addition.
- Run Mix Cycle set-up.

The Hydro-Control IV Operator terminal front panel is shown in Figure 2. This is the unit through which all operator interaction with the system is performed.

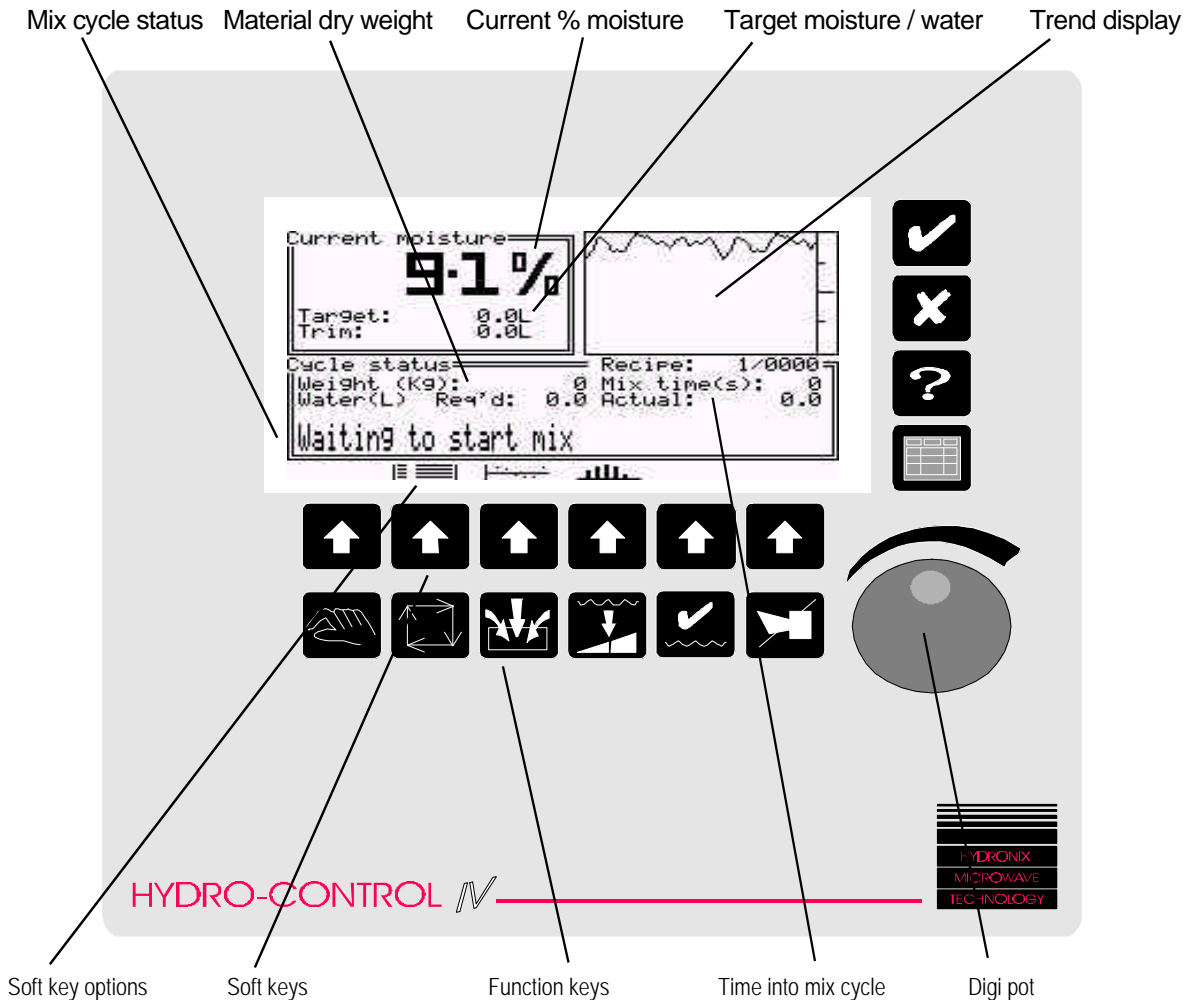

Figure 2 - Hydro-Control IV showing the Status Display

## 2.1 Switching on

When the Hydro-Control IV is first switched on at the mains (there is no ON/OFF switch), the display defaults to the Status Display screen above which shows the current status of the mix cycle and, in particular, the percentage moisture.

## 2.2 Adjusting the display contrast











If the front panel display is not very clear when the unit is switched on, the display contrast can be adjusted for optimum viewing by pressing the **X** key until the desired contrast is achieved.

## 2.3 Digi pot

The digital potentiometer on the front panel is used for data entry and selecting items from the menus by rotating clockwise or anti-clockwise.

## 2.4 Keypad functions

The functions of the keys on the Hydro-Control IV front panel are shown in Figure 3 below:

Legend	Name	Description
	Yes	Confirms changes to data.
	No	Cancels changes to data. Adjusts display contrast.
	Help	Not yet implemented.
	Select/Enter	Selects Main menu. Selects highlighted item in a menu. Accepts entered data.
	Manual Hold	Toggles between Manual Hold and Automatic modes. In manual hold mode the automatic cycle is paused and allows manual operation via soft key functions. May be User-code protected.
	Water Addition	Selects water addition method i.e. Automatic, Preset or Two Point calibration modes.
	Recipe select	Selects recipe number for next automatic mixing cycle.
	Water Trim or Preset water volume	Adjusts final mix by "trimming" the calculated amount of water when in automatic water addition mode.  Sets pre-set water volume when in pre-set water or two point calibration mode.
	Calibrate or Calibration water volume	Calibrates the selected recipe from the mix log.  Adjusts Calibration Water amount when Calibration mode is selected.
	Alarm Mute	Clears external alarm and displays historical log of alarms.
	Soft key	Selects soft key functions represented by the icons described in Figure 4 opposite.

















**Figure 3 - Keypad functions**









## 2.5 Soft key functions

The functions of the soft keys  vary depending on which menu has been selected and which mode the Hydro Control IV is operating in.

The functions are represented as icons above the soft keys and their meaning is given in Figure 4.

Icon	Name	Description
	Status display	Changes current display to show cycle status display.
	Mix log display	Selects mix log display to show results of 100 most recent mixing cycles.
	Error trend display	Displays contents of mix log as an error trend graph showing the difference between required and actual final moisture content.
	Error distribution	Displays contents of mix log as an error distribution graph with tolerance bands set by user.
	Add water	Opens fine water valve for as long as the key is pressed. Available in hand mode only.
	Abort cycle	Aborts current automatic cycle and resets cycle to beginning. Available in hand mode only.
	Exit	Returns to the previous display or menu.
	Cursor up	Moves highlight cursor to previous menu item. This can also be done with the digi pot.
	Cursor down	Moves highlight cursor to next menu item. This can also be done with the digi pot.
	Increment value	Increases numeric value during editing. Holding the key down will speed up the count. This can also be done with the digi pot.
	Decrement value	Decreases numeric value during editing. Holding the key down will speed up the count. This can also be done with the digi pot.
	More	Indicates more information is available.
	Record	Starts recording sensor capture data.
	Zoom in	Increases magnification on sensor capture display.
	Zoom out	Decreases magnification on sensor capture display.
	Log in	Logs in operator by requesting a user code.  <i>See Chapter 3 for further information.</i>

Icon	Name	Description
	Log out	Logs out operator.
	One	Enters digit <b>1</b> in User code.
	Two	Enters digit <b>2</b> in User code.
	Three	Enters digit <b>3</b> in User code.
	Four	Enters digit <b>4</b> in User code.
	Five	Enters digit <b>5</b> in User code.

**Figure 4 - Soft key function**

This chapter is a quick reference guide to get you started on using the Hydro Control IV front panel as quickly as possible.



It describes how to find your way around the menus, how to view recipes, how to adjust values and how to log in and out of the system by entering the correct user code.

### 3.1 Using the menus



Communication with the Hydro Control IV is done via the front panel through a series of menus that allow you to view or edit information about your system or the recipe to be used in the mix cycle.

The following simple tasks are designed to help you learn how to operate the front panel keypad and find your way around the menus:

To select the Main Menu

Task	Action	Comment
Select Main Menu	Press 	Screen displays Main Menu with a list of options or sub menus: 

To select an option

Task	Action	Comment
Scroll through options	Rotate digipot or use soft keys  and 	The highlighted cursor moves up/down the menu options.  Keep scrolling forward to see if any more options are available.
Select an option	When required option is highlighted, press 	Selected option is displayed.

To exit

Task	Action	Comment
Exit	Press soft key 	

The complete structure of the Main Menu is shown in *Appendix E "Menu map"* and a description of each menu and its' parameters is given in *Chapter 7 "Configuration menus"*.

## 3.2 Viewing display pages

The Hydro Control IV contains a number of display pages with useful information on the current status of the system, historical information from previous mix cycles and some diagnostic displays to aid investigations into system problems.







Some of the displays can be accessed directly from the front panel keypad by pressing the relevant key; others are accessed from the Main Menu.

Chapter 8 "Display pages" gives a description of each display page and how it is accessed.

## 3.3 Viewing a recipe

The Hydro-Control IV contains information on up to 200 recipes.

To view the contents of a specific recipe:

Task	Action	Comment
From Main Menu select "Recipe database"	Rotate digipot until required option is highlighted and press 	Screen displays "Recipe database" options 
Select "View recipe"	Rotate digipot until required option is highlighted and press 	Screen displays: 
Select "recipe number" to view	Rotate digipot until required value is reached and press 	Screen displays contents of selected recipe: 
Exit	Press 	Screen returns to Main Menu.





### 3.4 Adjusting values



To make changes to the data stored in the Hydro Control IV, you will need to be logged in under the correct user code as described at the end of this chapter.



Two methods are available for adjusting values in the system.

#### Adjusting values directly from the keypad

The following values can be adjusted directly from the front panel keypad without going through any menus:

Value	Key
Recipe number	
Water trim volume	
Pre-set water volume	
Calibration water volume	





By selecting the relevant key, the screen will display the current value and you can enter the new value either by rotating the digipot or using the soft keys  or .

Press  to accept the new value or  to cancel.



#### Adjusting values in menus

Most values are adjusted from within a menu as demonstrated in the example below:

Example: To adjust Pre-wet mix time

Task	Action	Comment
From Main Menu select "View recipe".	See previous section "Viewing a recipe"	Screen displays contents of selected recipe.
Select "Pre-wet mix time"	Rotate digipot until required option is highlighted and press 	Screen displays current value: 
Adjust value	Rotate digipot until required value is reached or use soft keys  or  Press 	Screen displays new value.

(continued)

Task	Action	Comment
Exit	Press 	Screen requests confirmation to update recipe: 

Press  to update the list or  to cancel the changes.

### 3.5 Logging In/Out with the user code

The Hydro Control IV has four different levels of security and some of its menus or data may not be accessible without entering the correct user code.

When the unit is first switched on, it is in 'Operator' mode; this requires no user code and allows a limited choice of menus and restricted access to some of the functions.

If you attempt a task for which you have insufficient access, the following warning is displayed:





To gain access to all the features on the system, you will need to "Log In" with the correct user code as described below.







#### User codes

The system has four levels of security where each level is defined as a "User" with certain privileges as summarised below provided the correct user code has been entered.

User	Privileges
Operator	Read/write access to day-to-day running of system.
Supervisor	Read/write access to all production parameters and can calibrate system.
Engineer	Read/write access to all parameters.
Backup/Restore	Read/write access to some parameters and Backup/restore utilities.

The user codes are given in *Appendix I* and can be entered from any display in the system wherever  and  are available, which includes all of the menus but not default displays.





## To Log In

Task	Action	Comment
Select <b>Main Menu</b>	Press 	Displays Main Menu
<b>Log In</b>	Press 	Display prompts you for user code. 
Enter user code	Enter code using soft keys  (1) through  (5) as required and press 	See <i>Appendix I</i> for User Codes.
Return to Status Display screen	Press 	

If the user code is valid, more menu options are displayed. If the code is invalid, a warning will be displayed to say that you have entered the wrong code.

Once you have completed the required operations under the Supervisors' code, you can reset the Hydro Control IV back to Operators' mode by "Logging Out" as follows:

## To Log Out

Task	Action	Comment
Select <b>Main Menu</b>	Press 	Displays Main Menu
<b>Log Out</b>	Press 	Display asks you to confirm you want to log out 
Confirm	Press 	

The Hydro Control IV can store information on up to 200 recipes in the “Recipe database”.

This chapter describes how to create a new recipe and edit it. It also describes how to create a default recipe, which can then be copied and edited.

**Note:** To perform any of these operations you will need to be Logged In to the system under the Supervisors’ user code as described in *Chapter 3 “Getting started”*.

## 4.1 Recipe database options

Select by pressing

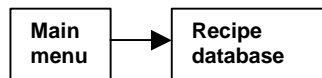

The options in the above display are as follows:

<i>View recipe</i>	To view or edit a selected recipe.
<i>Source recipe</i>	Enter the recipe number to be used as the source (i.e. “from”) when copying a recipe.
<i>Destination recipe</i>	Enter the recipe number to be used as the destination (i.e. “to”) when copying a recipe or resetting a recipe.
<i>Copy recipe</i>	Copy the source recipe to the destination recipe.
<i>Reset recipe</i>	Reset the destination recipe to default values.
<i>Print recipe</i>	Print the source recipe.









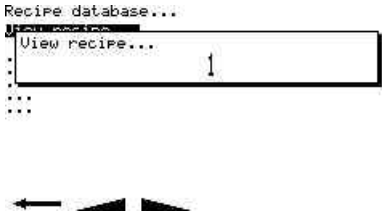

Changes to recipe values will not be implemented until the entire recipe is edited and the changes confirmed to update the recipe.

A change to a recipe will result in a printout of that recipe if a printer is installed.



## 4.2 Creating/editing a new recipe

To create a new recipe, you must select a recipe from the "Recipe database" and edit it with the required values as described in the sequence below.

Task	Action	Comment
Enter the main menu	Press 	Main Menu is displayed
Select "Recipe database"	Rotate digipot until "Recipe database" is highlighted and Press 	"Recipe database" options are displayed
Select "View recipe"	Rotate digipot until "View recipe" is highlighted and Press 	Display shows 
Enter recipe number to be edited	Rotate digipot to required value and press 	Display shows contents of selected recipe 
Edit recipe	Rotate digipot until value to be edited is highlighted and press 	Screen prompts for new value.
Enter new values	Rotate digipot to required value and press   Scroll to next value to be edited and repeat above	This saves the new value. To exit without saving Press 
Update recipe	Press  to exit menu  Press  to update recipe	Screen prompts, "Update recipe?"  Screen returns to "Recipe database" menu
To exit	Press 	Screen returns to Main Menu

## Recipe database example values

The following table gives some example values for the different parameters in the recipe.













A detailed description of each parameter in the “Recipe database” is given in *Chapter 7 “Configuration menus”*.

Parameter	Example value	Default Value
Dry weight of mix (kg)	1000	200
Cement weight (kg)	100	50
Pre-wet water (litres)	0	0.0
Pre-wet mix time (sec)	0	0
Cement call enable	0	0
Pre-set water (litres)	60.0	5.0
Calibration water (litres)	0	2.5
Auto water (%)	8.0	0.0
Water trim (litres)	0	0.0
Auto water limit (litres)	100.0	120.0
Auto water enable	1	0
Dry mixing time (sec)	30	15
Admix 1 call enable	0	0
Admix 2 call enable	0	0
Wet mixing time (sec)	30	20
Plus tolerance (%)	0.5	1.0
Minus tolerance (%)	-0.5	-1.0
Batch counter	20	0
Unscaled input 1	Updated by calibration	4.15
Moisture 1	Updated by calibration	0.00
Unscaled input 2	Updated by calibration	28.40
Moisture 2	Updated by calibration	11.00
Unscaled input 3	Updated by calibration	28.40
Moisture 3	Updated by calibration	11.00

### 4.3 Copying a default recipe

The simplest method of creating a new recipe is to copy and edit an existing recipe that closely resembles the new one.

It is recommended that a default recipe be set up in, say, **recipe 200** as described in the previous section and that this is copied and edited as shown below:

Task	Action	Comment
Enter the Main Menu	Press 	Main Menu is displayed
Select "Recipe database"	Rotate digipot until "Recipe database" is highlighted and press 	"Recipe database" options are displayed
Select "Source recipe"	Rotate digipot until "Source recipe" is highlighted and press 	Screen prompts for "Source recipe"
Enter recipe number to be copied <b>FROM</b>	Rotate digipot or use soft keys  or  then press 	Select recipe <b>200</b> as the source.
Select "Destination recipe"	Scroll down with digipot and press 	Screen prompts for "Destination recipe"
Enter recipe number to be copied <b>TO</b>	Rotate digipot or use soft keys  or  then press 	
Copy recipe	Scroll to "Copy recipe" and press 	Screen displays "Confirm copy recipe"
Confirm copy	Press 	The <b>Source</b> recipe is now copied into the <b>Destination</b> recipe
Reset recipe numbers	Set the Source recipe and Destination recipe to <b>1</b> .	<b>Important!</b> This will prevent accidental overwriting of recipes when copying is next performed
Exit	Press 	Screen returns to status display

The new recipe can now be edited as described in the previous section and it is then ready for calibration.

This chapter explains why it is necessary to calibrate the Hydro Mix sensor each time a new recipe is created and describes the three methods used by the Hydro Control IV unit.

## 5.1 Why calibrate?

The Hydro-Mix sensor measures the moisture content of the dry and wet mixes by measuring a change in a physical property of the material caused by the presence of water.

However, this property is not solely dependent on water content and so it is necessary to calibrate the sensor for each different recipe or combination of raw materials.

The output of the sensor gives a linear response to moisture increases up to ~ 20% moisture, making the HM05/HC IV system suitable even for wet mixes.

The Hydro Control IV calculates the slope of the calibration line by taking readings from the sensor during a mix cycle at points defined by the selected method of calibration.

Due to the characteristics of the mixtures and the sensitivities and accuracies required in each application, the optimum method of calibration will depend on whether a dry or wet cast is required and on whether admixes are to be added during the mix cycle.

**It is therefore very important to choose the correct calibration method for your particular application.**

## 5.2 Calibration methods

The Hydro Control IV uses three methods of calibrating the sensor depending on the type of product required:

- **Preset**  
This method is for dry cast and block products **without** colour or additives. It is used when a new recipe is being configured. A preset amount of water is added to the mix to give the required percentage of moisture and then calibration takes place.
- **Two Point Calibration**  
This method is for dry cast and block products **with** colour or additives and **wet cast** with or without additives. It is essentially the same as Preset mode except that the water is added in two amounts and readings are taken at two points. This is necessary for wet mixes where the sensor characteristics become less linear as the material reaches saturation. It also allows for the addition of admixes, if required, and this is done at the second water addition.
- **Automatic**  
**This method is** for dry cast and block products **without** colour or additives. It uses a historically “good mix” from the mix log for a batch that previously produced the correct product.

## 5.3 Preset mode

This mode is used when a new recipe is being configured for a dry cast mix without colour or additives.

A preset amount of water is added to the mix to achieve a target percentage moisture and the system is calibrated once a satisfactory mix has been obtained. Since this is a dry mix, the sensor characteristics are linear and an accurate calibration can be obtained by taking sensor readings at the start and end of the mix cycle and calculating the slope.

Once calibration is complete, the data is stored in the mix log as a “good mix” ready for future calibrations. The Hydro Control IV can then be set to run in Automatic mode.

### Example

Assume a new recipe has been set up with the following parameters:



Dry weight of mix = **1000kg**  
 Auto water (Target moisture content) = **8%**

Assume: Moisture content before mix cycle begins = **2%**



Therefore: Amount of water present in mix at start = **20 litres** (since 1 litre weighs 1 kg)  
 Amount of water required by end of mix cycle = **80 litres**.  
 Preset amount of water needed to achieve correct moisture content = **60 litres**.

The following sequence demonstrates how to perform a Preset calibration using the example above:

#### Step 1: Select Preset mode





Task	Action	Comment
Select water addition method	Press 	Screen prompts “Water method:”
Select Preset mode	Rotate digi pot to “Preset” and press 	Screen displays “Preset mix next”

#### Step 2: Enter Preset water

Set Preset water volume	Press 	Screen prompts “Adjust water for recipe:”
Enter the number for the new recipe	Rotate digi pot to required value and press 	Screen prompts “Preset water (L)”
Enter Preset water to be added to mix during Main Water addition e.g. <b>60 litres</b>	Rotate digipot to required value and press 	Screen returns to status display.  <b>Note:</b> The total amount of water does not include any Pre Wet water

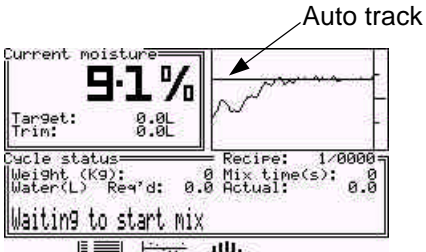
(continued)

Step 3: Make the new mix

Start mix cycle and observe Hydro Control IV display.		Dry mix cycle begins. Screen displays both dry and total mixing time elapsed.
10 seconds before end of <b>DRY MIX</b> cycle	Press 	Dry mix cycle will be paused. Screen displays "Hand mode selected"
Observe trend display on front panel	Wait until trend display is stable and that the auto track line is drawn across the display	The display will show:  Note time taken from start of cycle to auto track line being drawn; this will be used as the dry mix time
	Wait a few more seconds to ensure moisture content does not drift or auto track line disappear	If it does, wait until moisture content stops drifting or auto track line is drawn once more. Note time taken from start of dry mix cycle
Return system to <b>Automatic</b>	Press 	The system will now complete the dry mix cycle, add the Preset water and enter the wet mix cycle.
10 seconds before end of <b>WET MIX</b> cycle	Press 	The Wet Mix cycle will be paused. Screen displays "Hand mode selected"
Observe the mix in the mixer to confirm that it is of the correct moisture content	Press  if more water is required	Take care not too add to much water as water can only be added not removed
Observe the trend display on the front panel	Wait until trend display is stable and that the auto track line is drawn across the display	Note time taken from start of wet mix cycle to auto track line being drawn; this will be used as the wet mix time
	Wait a few more seconds to ensure moisture content does not drift or auto track line disappear	If it does, wait until moisture content stops drifting or auto track line is drawn once more. Note time taken from start of wet mix cycle
Return system to <b>Automatic</b>	Press 	The system will now complete the wet mix cycle.







When the wet mix cycle is complete the status display will show "Mix Complete" and the mix can be discharged from the mixer.

If the Dry and Wet Mix times recorded during the calibration are different from those in the recipe, then you will need to edit the recipe with the revised values.

#### Step 4: Calibrate the recipe from the mix log

Once the mix cycle is completed, all the readings are stored automatically in the mix log. A batch number is assigned to that mix, in the form RRR/BBBB where RRR denotes recipe number and BBBB the batch number.

It is now necessary to calibrate the Hydro Control IV to that recipe batch.

Task	Action	Comment																																																																														
Display the mix log	Press 	The results of the most recent 100 mixing cycles (or less if 100 cycles have not been completed) will be displayed.																																																																														
Select the required recipe from the mix log	Rotate digipot to highlight the mix to be used for calibration  <table border="1"> <thead> <tr> <th>Recipe</th> <th>Batch (Kg)</th> <th>Target (%/L)</th> <th>Actual (L)</th> <th>DRY (%)</th> <th>FINAL (%)</th> </tr> </thead> <tbody> <tr><td>2/0705</td><td>2950</td><td>4.0%</td><td>94.0</td><td>1.62</td><td>4.82</td></tr> <tr><td>2/0706</td><td>2950</td><td>4.0%</td><td>94.0</td><td>1.64</td><td>4.82</td></tr> <tr><td>2/0707</td><td>2950</td><td>4.0%</td><td>94.0</td><td>1.64</td><td>4.82</td></tr> <tr><td>2/0708</td><td>2950</td><td>4.0%</td><td>94.0</td><td>1.64</td><td>4.82</td></tr> <tr><td>2/0709</td><td>2950</td><td>4.0%</td><td>94.0</td><td>1.64</td><td>4.82</td></tr> <tr><td>1/0001</td><td>0</td><td>5.0%</td><td>5.0</td><td>0</td><td>???</td></tr> <tr><td>1/0002</td><td>0</td><td>5.0%</td><td>5.0</td><td>2.06</td><td>3.76</td></tr> <tr><td><b>1/0003</b></td><td><b>200</b></td><td><b>10.0</b></td><td><b>10.0</b></td><td><b>1.73</b></td><td><b>7.68</b></td></tr> <tr><td>1/0004</td><td>200</td><td>10.0</td><td>10.0</td><td>1.77</td><td>7.76</td></tr> <tr><td>1/0005</td><td>200</td><td>12.0</td><td>12.0</td><td>-0.27</td><td>7.32</td></tr> <tr><td>1/0006</td><td>200</td><td>16.0</td><td>16.0</td><td>-1.06</td><td>7.78</td></tr> <tr><td>1/0007</td><td>200</td><td>16.0</td><td>16.0</td><td>-1.06</td><td>7.86</td></tr> </tbody> </table>	Recipe	Batch (Kg)	Target (%/L)	Actual (L)	DRY (%)	FINAL (%)	2/0705	2950	4.0%	94.0	1.62	4.82	2/0706	2950	4.0%	94.0	1.64	4.82	2/0707	2950	4.0%	94.0	1.64	4.82	2/0708	2950	4.0%	94.0	1.64	4.82	2/0709	2950	4.0%	94.0	1.64	4.82	1/0001	0	5.0%	5.0	0	???	1/0002	0	5.0%	5.0	2.06	3.76	<b>1/0003</b>	<b>200</b>	<b>10.0</b>	<b>10.0</b>	<b>1.73</b>	<b>7.68</b>	1/0004	200	10.0	10.0	1.77	7.76	1/0005	200	12.0	12.0	-0.27	7.32	1/0006	200	16.0	16.0	-1.06	7.78	1/0007	200	16.0	16.0	-1.06	7.86	Select the batch number of the mix you have just completed  Pressing  will display more columns of information
Recipe	Batch (Kg)	Target (%/L)	Actual (L)	DRY (%)	FINAL (%)																																																																											
2/0705	2950	4.0%	94.0	1.62	4.82																																																																											
2/0706	2950	4.0%	94.0	1.64	4.82																																																																											
2/0707	2950	4.0%	94.0	1.64	4.82																																																																											
2/0708	2950	4.0%	94.0	1.64	4.82																																																																											
2/0709	2950	4.0%	94.0	1.64	4.82																																																																											
1/0001	0	5.0%	5.0	0	???																																																																											
1/0002	0	5.0%	5.0	2.06	3.76																																																																											
<b>1/0003</b>	<b>200</b>	<b>10.0</b>	<b>10.0</b>	<b>1.73</b>	<b>7.68</b>																																																																											
1/0004	200	10.0	10.0	1.77	7.76																																																																											
1/0005	200	12.0	12.0	-0.27	7.32																																																																											
1/0006	200	16.0	16.0	-1.06	7.78																																																																											
1/0007	200	16.0	16.0	-1.06	7.86																																																																											
Calibrate the mix	Press 	Screen prompts "Calibrate to this mix?"																																																																														
Confirm you wish to use this mix log entry for calibration	Press 	Screen displays: "Calibration was successful".																																																																														
Exit	Press 	Screen returns to status display																																																																														
Select Automatic mode	Press 	Screen prompts: "Water method:"																																																																														
	Rotate digi pot to "Automatic" and press 	Screen displays: "Auto Mix Next"																																																																														

#### Step 5: Re-calibrate the recipe in Automatic mode

Although the new recipe is now calibrated it is recommended that you run the system in fully Automatic mode to produce another batch to confirm the calibration. In this mode, the water will be added automatically although some manual trimming may still be necessary to produce the exact required product.

Once the mix cycle is completed and the "mix complete" message is displayed, **repeat step 4 above**, this time selecting the **new** batch number as the calibration mix.

The Hydro Control IV is now fully calibrated for the new mix design and each time the new recipe is mixed, it will use the calibration data from that batch to ensure that the correct product is produced.

**Note:** An asterisk (\*) is displayed in the mix log beside the batch number used for calibration.

## 5.4 Two Point Water Addition Mode

This mode is used when colour or additives are to be added to dry cast products or for wet cast above 20% moisture content with or without additives.

The water is added in two parts and calibration readings are taken at the start of the mix cycle and after the first water addition.

The amount of water added at the first water addition is defined as the **Calibration water**.

The **total** amount of water added to the mix (excluding any water in the pre-wet mix) is known as the **Preset water** and this is defined in the recipe. The Hydro Control IV automatically calculates the second water addition by subtracting the Calibration water from the Preset water.

It is recommended that the Calibration water be set to 50% of the Preset water for wet cast and 90% for dry cast.

Any admixes controlled by the Hydro Control IV admix signals will be added during the second water addition.

### Example

Assume a new recipe has been set up for a wet cast application with the following parameters:



Dry weight of mix = **1000 kg**  
 Auto water (Target moisture content) = **11%**

Assume: Moisture content before mix cycle begins = **2%**

Therefore: Amount of water present in mix at start = **20 litres** (since 1 litre weighs 1 kg)  
 Amount of water required by end of mix cycle = **110 litres**.  
 Preset water needed to achieve correct moisture content = **90 litres**.  
 Calibration water required at first water addition = **45 litres**

The following sequence demonstrates how to perform a Two Point calibration using the example above:



### Step 1: Select Two Point Water Addition Mode

Task	Action	Comment
Select water addition method	Press 	Screen prompts "Water method:"
Select Two Point Water Addition mode	Rotate digi pot to "2 Point Calibration" and press 	Screen displays "Calibration mix next"



*(continued)*



### Step 2: Enter Calibration water (first water addition)

Set Calibration water volume	Press 	Screen prompts "Adjust water for recipe:"
Enter recipe number	Rotate digipot to required value and press 	Screen prompts "Set calibration water"
Enter Calibration water to be added to mix at first water addition e.g. <b>45 litres</b>	Rotate digipot to required value and press 	Screen returns to status display.  <b>Note:</b> Set calibration water to 50% of Preset water.  For dry cast with admix or colour set to 90% of Preset water.

### Step 3: Enter Preset water

Set Preset water volume	Press 	Screen prompts "Adjust water for recipe:"
Enter recipe number	Rotate digipot to required value and press 	Screen prompts "Preset water (L)"
Enter Preset water e.g. <b>90 litres</b>	Rotate digipot to required value and press 	Screen returns to status display.  <b>Note:</b> Preset is the total amount of water to be added (excluding any pre wet water).

### Step 4: Make the new mix

As described in Preset mode except that the water will be added in two parts.

Any checks on the mixture, or trimming of the water should be done at the end of the second water addition.

### Step 5: Calibrate the recipe from the mix log

As described in Preset mode. (*Section 5.3*).

**Note:** Having calibrated a mix using the Two Point calibration method, it is not possible to recalibrate using the Automatic calibration method. The calibration must be carried out using the Two Point method once more.

## 5.5 Automatic Calibration Mode







This method is used when a previous “good mix” has already been produced and the data for that batch has been stored in the mix log.

The system must be running in **Automatic mode** and any recipe, (**except** those calibrated using the Two Point method) can be recalibrated simply by selecting a good mix from the mix log and pressing the Calibrate key.

For example, assume that while running in Automatic mode, it is necessary to keep making the same minor adjustments to a recipe each time a batch is made in order to achieve a satisfactory product at the end of the cycle. By selecting the latest ‘good’ batch from the mix log and pressing the Calibrate key, the recipe will now be recalibrated to that mix without having to perform a complete Preset calibration as though it were a new recipe.

In the mix log, an asterisk will be displayed beside the batch number of the mix that is being used to calibrate a particular recipe.

**Note:** A warning will be displayed if recalibration is attempted of a recipe previously calibrated by the Two Point method. This can be overwritten, but the resulting calibration may be incorrect.

Task	Action	Comment																																																																														
Display mix log	Press 	The results of the most recent 100 mixing cycles (or less if 100 cycles have not been completed) will be displayed.																																																																														
Select a recipe from the mix log	Using the digipot, highlight the mix to be used for calibration  <table border="1" data-bbox="485 1084 973 1348"> <thead> <tr> <th>Recipe</th> <th>Batch (Kg)</th> <th>Target (%/L)</th> <th>Actual (L)</th> <th>DRY (%)</th> <th>FINAL (%)</th> </tr> </thead> <tbody> <tr><td>2/0705</td><td>2950</td><td>4.0%</td><td>94.0</td><td>1.62</td><td>4.4</td></tr> <tr><td>2/0706</td><td>2950</td><td>4.0%</td><td>94.0</td><td>1.62</td><td>4.4</td></tr> <tr><td>2/0707</td><td>2950</td><td>4.0%</td><td>94.0</td><td>1.62</td><td>4.4</td></tr> <tr><td>2/0708</td><td>2950</td><td>4.0%</td><td>94.0</td><td>1.62</td><td>4.4</td></tr> <tr><td>2/0709</td><td>2950</td><td>4.0%</td><td>94.0</td><td>1.62</td><td>4.4</td></tr> <tr><td>1/0001</td><td>0</td><td>0.0%</td><td>0.0</td><td>0.0</td><td>0.0</td></tr> <tr><td>1/0002</td><td>0</td><td>0.0%</td><td>0.0</td><td>0.0</td><td>0.0</td></tr> <tr><td>1/0003</td><td>200</td><td>10.0%</td><td>10.0</td><td>1.70</td><td>10.0</td></tr> <tr><td>1/0004</td><td>200</td><td>10.0%</td><td>10.0</td><td>1.70</td><td>10.0</td></tr> <tr><td>1/0005</td><td>200</td><td>10.0%</td><td>10.0</td><td>1.70</td><td>10.0</td></tr> <tr><td>1/0006</td><td>200</td><td>10.0%</td><td>10.0</td><td>1.70</td><td>10.0</td></tr> <tr><td>1/0007</td><td>200</td><td>10.0%</td><td>10.0</td><td>1.70</td><td>10.0</td></tr> </tbody> </table>	Recipe	Batch (Kg)	Target (%/L)	Actual (L)	DRY (%)	FINAL (%)	2/0705	2950	4.0%	94.0	1.62	4.4	2/0706	2950	4.0%	94.0	1.62	4.4	2/0707	2950	4.0%	94.0	1.62	4.4	2/0708	2950	4.0%	94.0	1.62	4.4	2/0709	2950	4.0%	94.0	1.62	4.4	1/0001	0	0.0%	0.0	0.0	0.0	1/0002	0	0.0%	0.0	0.0	0.0	1/0003	200	10.0%	10.0	1.70	10.0	1/0004	200	10.0%	10.0	1.70	10.0	1/0005	200	10.0%	10.0	1.70	10.0	1/0006	200	10.0%	10.0	1.70	10.0	1/0007	200	10.0%	10.0	1.70	10.0	Pressing  will display more columns of information
Recipe	Batch (Kg)	Target (%/L)	Actual (L)	DRY (%)	FINAL (%)																																																																											
2/0705	2950	4.0%	94.0	1.62	4.4																																																																											
2/0706	2950	4.0%	94.0	1.62	4.4																																																																											
2/0707	2950	4.0%	94.0	1.62	4.4																																																																											
2/0708	2950	4.0%	94.0	1.62	4.4																																																																											
2/0709	2950	4.0%	94.0	1.62	4.4																																																																											
1/0001	0	0.0%	0.0	0.0	0.0																																																																											
1/0002	0	0.0%	0.0	0.0	0.0																																																																											
1/0003	200	10.0%	10.0	1.70	10.0																																																																											
1/0004	200	10.0%	10.0	1.70	10.0																																																																											
1/0005	200	10.0%	10.0	1.70	10.0																																																																											
1/0006	200	10.0%	10.0	1.70	10.0																																																																											
1/0007	200	10.0%	10.0	1.70	10.0																																																																											
Calibrate the mix	Press 	Screen prompts “Calibrate to this mix?”																																																																														
Confirm you wish to use this mix log entry for calibration	Press 	Screen displays “Calibration was successful”  The data stored in the mix log has been used to calibrate the selected recipe.																																																																														
Exit	Press 	Screen returns to status display																																																																														
Select Automatic mode	Press 	Screen prompts: “Water method.”																																																																														
	Rotate digipot to “Automatic” and press 	Screen displays “Auto Mix Next”																																																																														

## 5.6 Adjusting calibration values manually

The Preset and Two Point calibration methods rely on a subjective visual assessment that the mix cycle used for calibration matched the required target. In general, this may suffice but if more accuracy is required, then you should analyse a sample of the mix used for calibration (normally with a 'bake-out' test) and manually correct the values stored in the recipe as follows:

### Example

Following calibration, the Moisture 3 parameter (inferred moisture reading at end of wet mix phase) in the recipe = 8.9%. This is the same as the Auto water (final target moisture).

Assume the bake-out test = 8.5%

Difference between calibration value and bake-out test = - 0.4 %

Moisture 1, Moisture 2 and Moisture 3 must be adjusted as shown below:

Parameter	Before adjustment	After adjustment
Moisture 1 %	6.3	5.9
Moisture 2 %	7.5	7.1
Moisture 3 %	8.9	8.5

The effect of this adjustment is to offset the calibration line by the required amount.

## 5.7 Calibration problems





The following is a list of some of the more common problems that may occur during calibration:

Problem	Remedy
Alarm recorded	Determine cause of alarm by displaying the alarm log.
Mix not stable at end of dry or wet mix cycle	Increase dry or wet mix time. Both dry and wet mix times are recorded in mix log.
Insufficient moisture change	Hydro Control IV requires minimum of 1% moisture change between wet and dry cycles.
Final moisture reading is wrong	The % moisture values displayed are meaningless <b>until</b> a calibration has been performed,
Sensor has build up of material on the ceramic	Adjust position of sensor and/or adjust mixer paddles to ensure ceramic is kept clean.
Problems during small or part batches	Insufficient material in mixer to provide good sensor coverage. Increase mix size or run in Preset mode with small batches.

This chapter describes the day to day running of the mix cycle and includes how to clear alarms and how to abort the mixing cycle.

**Note:** During normal operation in Automatic mode, it may be necessary to recalibrate an existing recipe; this has already been described in detail in *Chapter 5, "Calibration"* in section 5.5 "*Automatic calibration mode*" and has therefore not been included in this chapter.

## 6.1 Starting the mix cycle

Task	Action	Comment
Select the recipe for the next mix cycle	Press 	Screen prompts: "Select recipe number"
	Rotate digipot to required recipe number and press 	If a mix cycle is currently in progress, the new recipe number will not be displayed until the present cycle has been completed.
Select water addition method	Press 	Screen prompts: "Water method"
Select Automatic	Rotate digipot to "Automatic" and press 	Screen displays "Auto mix next"

The system is now ready to start the mix cycle.

In some systems, a remote device such as a batch controller or computer selects the recipe automatically. In these circumstances, it is not possible to select the recipe from the keyboard and a warning message is displayed if attempted.

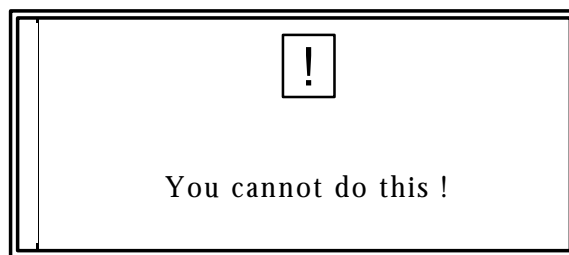



## 6.2 Choosing Manual Hold or Automatic Mode

Sometimes it is necessary to pause the mix cycle during Automatic operation, for example to check the mix visually or to manually add water. To do this, the system needs to be in Manual Hold mode.

Manual Hold mode may be selected at any time and simply halts the sequence at a particular step. However, it should not be selected without due consideration as to the possible effects on the material in the mixer.

### Manual Mode

Task	Action	Comment
To change to Manual mode	Press 	Mix cycle will be paused. Screen displays: 

Note that the soft keys  (add water) and  (abort cycle) now become available.





### Automatic mode

Task	Action	Comment
To return to Automatic mode	Press 	Mix cycle restarts. Screen displays "Current stage of mix cycle"

## 6.3 Adjusting the scale of the trend display

The trend signal on the status display shows the signal from the Hydro-mix sensor in graphical form.

If you need to adjust the vertical scale of the display in order to get better resolution then proceed as follows:

Task	Action	Comment
Enter Main Menu	Press 	Displays Main Menu
Select "sensor set up"	Rotate digipot until required option is selected and press 	Displays "sensor set-up" menu
Select "trend upper limit"	Rotate digipot until required option is selected and press 	Display prompts "trend upper limit (%)"
Enter new scale	Rotate digipot until required value is reached and press 	The trend lower limit or trend interval can be changed in the same way if required.
To exit	Press 	Screen returns to Main Menu



**Note:** This can only be done if you have logged in using the correct user code.

## 6.4 Selecting the water addition method

The Hydro Control IV system has three methods of controlling the addition of water during the mixing cycle:





Pre-set water addition	In this case, the water volume added is based on the pre-set value stored in the recipe and the readings from the Hydro Mix sensor are ignored.  This method is normally used during system set-up when establishing the correct operating parameters for a particular recipe, although it is also used as a fallback method in certain circumstances.
Automatic water addition	This is the normal method of operation for the system, and the volume of water to be added is computed from readings taken by the Hydro Mix sensor.
Two point calibration	This mode is used for wet cast products or dry cast products with additives and is essentially the same as Preset mode except the Hydro Control IV will add the water in two amounts. Admixes, if used, will be added to the mix during the second water addition. The first water addition, Calibration water, is normally set at 50% of the Preset water but may be adjusted to any value up to the Preset water value. The second water addition is set automatically and is calculated by the HC IV as the Preset water value minus the Calibration water.

To select the water addition method:

Task	Action	Comment
Enter Water addition key	Press 	Screen prompts "Water method: Automatic or Preset or 2 Point Calibration"
Select water method	Rotate digipot until required option is selected and press 	Screen displays selected water addition method.

## 6.5 Adjusting the pre-set water volume

When operating in pre-set water addition mode, the volume of water required can be set directly from the front panel:

Task	Action	Comment
Select "Preset water volume" key	Press 	Screen prompts for recipe number to set preset water.
Enter recipe number	Rotate digipot to required recipe number and press 	Screen displays current set value: 
Enter the volume of water required in litres.	Rotate digipot to required value and press 	

In some systems, a remote device such as a batch controller or computer sets the preset water volume automatically. In these circumstances, it is not possible to set the volume from the keyboard and a warning message is displayed if attempted.



## 6.6 Adjusting the calibration water volume

When operating in two point calibration water addition mode, the volume of calibration water required can be set exactly as described above for preset water volume, but using the following key: 

## 6.7 Trimming the water





### Manually

If the mix seems too dry, it is possible to open the water valve and manually trim the water during the Automatic mix cycle as follows:

Task	Action	Comment
Select Manual mode	Press 	Mix cycle will be paused and screen displays "Hand mode selected".
Select add water	Press and hold soft key  until sufficient water has been added then release	The fine water valve will be held open while the key is pressed. The amount of water added is shown in "Actual" on the status display.
Return to Automatic mode	Press 	Mix cycle restarts and screen displays "Auto mix next"

### Automatically

With the system running in automatic water addition mode, the amount of water to be added can be trimmed automatically by setting a value for water trim as follows:

Task	Action	Comment
Select "Water trim" key	Press 	Screen prompts for number of recipe to be trimmed.
Enter recipe number	Rotate digipot to required recipe number and press 	Screen displays current set value: 
Enter the volume of water trim required in litres.	Rotate digipot to required value and press 	This value is added to the volume of water calculated by the system at the end of the dry-mix period. A negative value reduces the volume by the amount indicated.

The water trim can only be adjusted if "Auto water enable" in the recipe database is set to 1 (achieved by performing a calibration on the recipe). If this parameter is not set, then the pre-set water volume will be adjusted instead irrespective of the water addition mode in use.

In some systems, a remote device such as a batch controller or computer sets the water trim volume automatically. In these circumstances, it is not possible to set the volume from the keyboard and a warning message is displayed if attempted.



## 6.8 Alarms

The Hydro Control IV alarm system has two types of alarms; **alarms** that require acknowledgement from the operator, and events that are logged but otherwise require no action.

If a problem occurs during a mix cycle, either an audible alarm will sound, or a message will appear on the screen.

### Clearing/acknowledging alarms

Task	Action	Comment
Clear/acknowledge alarm	Press 	Alarm is turned off and screen displays alarm log showing last 100 alarms or events with the most recent highlighted for attention. <div data-bbox="1066 651 1481 875" style="border: 1px solid blue; padding: 5px; margin-top: 10px;"> <pre>Alarm log... 0/0000 Sensor fault 1/0003 Dry mix time limit 1/0004 Mix too dry 1/0004 Mix too dry 1/0004 Mix too dry 1/0004 Mix too dry 1/0004 Mix too dry - rejected 1/0006 No water required 1/0006 Mix too wet 1/0006 Mix too wet - rejected</pre> </div>

Alarms and events are printed automatically if a printer is installed.

### Configuring the alarms

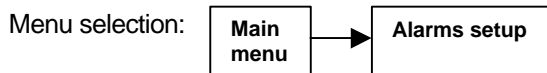

Each alarm can be enabled or disabled by selecting “Alarms set-up” from the Main Menu. To do this, you must be logged in under the correct user code.

Scroll through the list and select each alarm to be configured using one of the following options:

- With siren* Turns on the alarm output when the alarm occurs.
- Silent* Logs the event, but does not turn on the alarm output.
- Disabled* Does nothing when the event occurs.

A full description of the “Alarms set-up” menu is given in *Chapter 7 “Configuration Menus”*.

## 6.9 Dealing with out of spec mixes

If the final moisture value is outside the range permitted in the Plus/minus tolerances in the recipe database, an alarm will occur at the end of the mix cycle. This section describes how to deal with out of spec mixes.

### Mix too dry

When this alarm occurs, it is often possible to make a correction by the addition of water. If “operator correction” in the mixer control set-up menu is enabled, then the display shows:



Answering  in this case will result in a prompt for auto-correction:

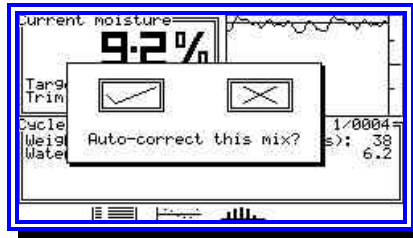

If you reply  the system will re-compute the water requirement and make the adjustment. It will then adjust the “correction wet mix time” parameter in mixer control set-up after which the final moisture check will again be performed as shown below, repeating the correction if necessary:

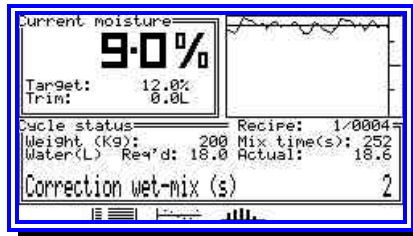

Replying  at the auto-correct prompt will cause the system to enter Hand mode, allowing a manual addition of water to be made. Following such correction, you should either re-select Auto mode or abort the current cycle.

Replying  at the “Mix too dry - fix?” prompt allows you to accept or reject the mix:



Pressing  here will accept the mix i.e. it will be treated as though it were within tolerance and the control system will be signalled accordingly.

Pressing  here will cause the control system to be signalled with a mix error condition. Normally, this would cause the mixer control system to dump the mix.

If “operator correction” is not enabled then some of these prompts will not occur and the control system will simply be signalled with the result, leading to a final display:

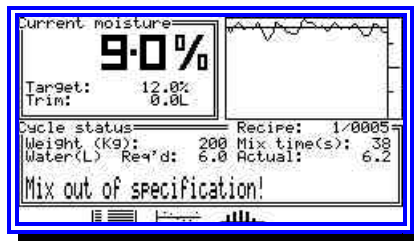

#### Mix too wet

When the “mix too wet” alarm occurs, it is not possible to make a correction. However, if “operator correction” is enabled, the display will prompt:











Pressing  here will accept the mix i.e. it will be treated as though it were within tolerance and the control system will be signalled accordingly.

Pressing  here will cause the control system to be signalled with a mix error condition. Normally, this would cause the mixer control system to dump the mix.

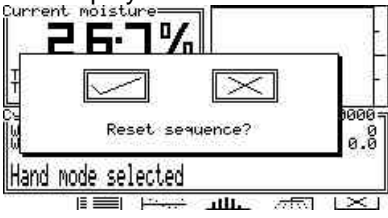
## 6.10 Aborting the current cycle

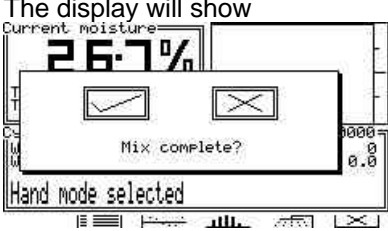
It may be necessary to terminate the current mixing cycle from the keypad, for example in the event of a sequence fault elsewhere in the control system.

To perform this operation:

Task	Action	Comment
Select "Manual hold"	Press 	Mix cycle will be paused. Screen displays "Hand mode selected".
To abort cycle	Press 	 is a soft key function.
		The display will show 
To reset cycle	Press 	This will reset the sequence.  will return to trend display with "Hand mode selected"
		The display will show 
Confirm	Press 	Screen returns to trend display with "Hand mode selected". A Mix Complete signal will be generated once Automatic mode is selected.   will return to trend display with "Hand mode selected". No Mix Complete signal will be generated.
Return to Automatic mode	Press 	Screen displays "Auto mix next" Mix Complete will be displayed and Mix Complete signal generated if selected as above.

The sequence will not be reset or the Mix Complete signal generated until the system is returned to the Automatic mode.

This chapter describes the System Configuration menus available on the Hydro Control IV.

These menus are accessed from the Main Menu, which is selected by pressing  from any default display page.

**Note:** Some options will not appear unless you have logged-in with the appropriate User-code.

## 7.1 Recipe database

Parameter	Units	Default	Range	Description
Dry weight of mix	Kg	200	0, 19999	Total dry weight of materials in the mixer. Used as the basis of automatic water addition. The value in the recipe will only be used if this is selected as the dry weight source in the Mixer Control Menu. This value <b>must include</b> the weight of cement.
Cement weight	Kg	50	0, 9999	Used to calculate the water/cement ratio in the mix log.
Pre-wet water	Litre	0	0, 500.0	Volume of water to dispense during pre-wet phase.
Pre-wet mix time	sec	0	0, 500	Delay between addition of pre-wet water and cement call (if enabled).
Cement call enable	None	0	0,1	The system will output a Cement Call and wait for a Cement Done input before continuing.
Pre-set water	Litre	5.0	0, 500.0	Volume of water to dispense in pre-set water mode.
Calibration water	Litre	0.0	0, 500	Volume of water to dispense in the first water addition when two point calibration mode is used,
Auto water	%	0.0	±20.0	Final target % in automatic water mode.
Water trim	Litre	0.0	As set in mixer control set-up	Operator adjustment to automatic volume calculated by the system.
Auto water limit	Litre	120.0	0, 999.9	Maximum amount of water that may be added in automatic mode.
Auto water enable	None	0	0,1	When 0, this recipe can only be used in pre-set water mode. When 1, this recipe can be used in either pre-set or automatic mode, depending on other system settings. The value is set to 1 when a calibration operation is performed.
Dry mixing time	sec	15	0, 500	Number of seconds to run for dry-mix period.
Admix 1 call enable	None	0	0,1	If enabled, will cause an Admix 1 Call to be output. The system will then wait for an Admix 1 Done input before continuing.
Admix 2 call enable	None	0	0,1	If enabled, will cause an Admix 2 Call to be output. The system will then wait for an Admix 2 Done input before continuing.

(continued)

Wet mixing time	sec	20	0, 500	Number of seconds between end of water addition to end of mix.
Plus tolerance	%	1.0	0.1, 5.0	Acceptable tolerance at end of wet mix before the mix is alarmed as 'too wet'.
Minus tolerance	%	-1.0	-0.1, -5.0	Acceptable tolerance at end of wet mix before the mix is alarmed as 'too dry'.
Batch counter	Count	0	0, 9999	Increments each time a mix is started on this recipe. Used to identify a mix in the mix log.
Unscaled input 1	None	4.15	0, 100.00	Unscaled input value read from sensor at end of dry-mix period. Updated by a calibration.
Moisture 1	%	0	0, 20.00	Inferred moisture reading at end of dry mix period. Updated by a calibration.
Unscaled input 2	None	28.40	0, 100.00	Unscaled input value read from sensor at end of inserted wet-mix phase (for mix set-up cycles). Updated by a calibration.
Moisture 2	%	11.00	0, 20.00	Inferred moisture reading at end of inserted wet-mix phase (for mix set-up cycles). Updated by a calibration.
Unscaled input 3 <sup>1</sup>	None	28.40	0, 100.00	Unscaled input value read from sensor at end of wet-mix phase. Updated by a calibration.
Moisture 3 <sup>2</sup>	%	11.00	0, 20.00	Inferred moisture reading at end of wet-mix phase. Updated by a calibration.

## 7.2 Mixer control set-up

Parameter	Units	Default	Range	Description
Operator correction	None	1	0, 1	If a mix is out of specification, this allows the operator to perform manual correction at the end of a mix before signalling the control system that the mix is complete.
Correction wet-mix time	%	50	10, 100	Specifies a % of the standard recipe wet-mix time that will be used in the event of an automatic water correction being made to a dry-mix. Also specifies the second wet-mix time for a two-shot cycle.
Auto-track time Dry	s	10	1, 30	Determines the moisture value stability period required to allow termination of the dry mix cycle.



(continued)

<sup>1</sup> Will usually be the same as Unscaled Input 2 unless admixes are used.

<sup>2</sup> Will usually be the same as Moisture 2 unless admixes are used.

Parameter	Units	Default	Range	Description
Auto-track deviation Dry	Moisture %	0.10	0.00 - 10.00	Sets a limit on the moisture reading deviation for it to be classed as 'stable' in the dry cycle.
Auto-track time Wet	s	10	1, 30	Determines the moisture value stability period required to allow termination of the wet mix cycle.
Auto-track deviation Wet	Moisture %	0.10	0.00 - 10.00	Sets a limit on the moisture reading deviation for it to be classed as 'stable' in the wet cycle.
Cement time-out	s	30	5 - 100	If cement control is enabled, this will cause an alarm if the <i>Cement done</i> input is not received within this time limit.
Cement fault action	None	Wait	Wait, Continue, Hand	Determines the subsequent action in the event of a cement time-out alarm.
Admix 1 delay	s	0	0 - 60	Delays the Admix 1 call after the main water addition has started.
Admix 1 rinse water	Litres	0.0	0 - 20.0	Amount of water held back to flush admix 1.
Admix 1 time-out	s	30	5 - 100	If admix 1 control is enabled, this will cause an alarm if the <i>Admix 1 done</i> input is not received within this time limit.
Admix 1 fault action	None	Wait	Wait, Continue, Hand	Determines the subsequent action in the event of a Admix 1 time-out alarm.
Admix 2 time-out	s	30	5 - 100	If Admix 2 control is enabled, this will cause an alarm if the <i>Admix 2 done</i> input is not received within this time limit.
Admix 2 fault action	None	Wait	Wait, Continue, Hand	Determines the subsequent action in the event of a Admix 2 time-out alarm.
Fine filter time	s	10	0 - 30	This determines when the system switches to the fine sensor filter parameters. The time is measured backwards from the end of the dry and wet mix periods.
Mix extension time	s	20	1 - 100	Sets a limit on how long the system will extend a mix phase to achieve a stable sensor reading.
Start-mix action	None	Continue	Wait, Continue, Hand	Determines the subsequent action in the event of loss of the <i>Start-Mix</i> input. Pulse start systems should set this to Continue.

(continued)

Parameter	Units	Default	Range	Description
Mix OK/ERR action	None	01 / 10	11 / 01, 01 / 11, 01 / 10	<p>These represent combinations of <i>Mix OK/ERR</i> and <i>Mix Complete</i> signals to provide interfacing flexibility at the end of the mix cycle. The combinations are interpreted as follows:</p> <p><u>11 / 01</u> Raise <i>Mix Complete</i> at the end of the mix cycle. Raise <i>Mix OK/ERR</i> for a GOOD MIX.</p> <p><u>01 / 11</u> Raise <i>Mix Complete</i> at the end of the mix cycle. Raise <i>Mix OK/ERR</i> for a BAD MIX.</p> <p><u>01 / 10</u> Raise <i>Mix Complete</i> for a GOOD MIX. Raise <i>Mix OK/ERR</i> for a BAD MIX.</p> <p>The options are derived from a binary representation of outputs 15 &amp; 14.</p>
Recipe number source	None	Keypad	Keypad, RS232, BCD, Discrete, Binary, HC4 Binary	<p>Determines where the current recipe number is to be obtained.</p> <p>If set to Keypad, the operator can select the recipe using .</p>
Dry weight source	None	Recipe	Recipe, RS232 Analogue	Determines where the dry weight value is to be obtained.
Auto % source	None	Recipe	Recipe, RS232	Determines where the current auto water % is to be obtained.
Pre-set water source	None	Keypad	Keypad, Recipe, RS232	<p>Determines where the current pre-set water target is to be obtained.</p> <p>If set to Keypad, the operator can change the value using .</p>
Trim source	None	Keypad	Keypad, Recipe, RS232	<p>Determines where the automatic water trim value is to be obtained.</p> <p>If set to Keypad, the operator can change the value using .</p>
RS232 port usage	None	Printer	None, Printer, Remote link, Trace	Determines how the RS232 serial port is to be used.
Trim limit (+/-)	Litres	10.0	0.0 - 100.0	Sets the limit by which an operator is allowed to adjust the water trim value.
Option flag	None	00000100	00000000 to 00111111	Note: Always set to default.



### 7.3 Mix log set-up

Parameter	Units	Default	Range	Description
Error bandwidth	%	0.5	0.1 - 1.0	Determines the bandwidth used in the error trend and error distribution displays.
Analysis by recipe	None	1	0,1	Determines if values displayed in the error trend and error distribution displays will be selected by recipe. 0 = displays entire mix log 1 = displays current recipe only
Clear mix log	None	---	---	Allows the current mix log data to be cleared.

## 7.4 Sensor set-up

Parameter	Units	Default	Range	Description
Trend interval	s	1.0	0.1 - 10.0	Determines how often the system records data to be displayed on the status display real-time trend.
Trend lower limit	%	0.00	-100.00 - +100.00	Determines the lower y-axis value of the real-time trend display.
Trend upper limit	%	10.00	-100.00 - +100.00	Determines the upper y-axis value of the real-time trend display.
Type	None	1	1 - 10	Determines the method used to process the sensor input signal. See Chap 10 (section 10.6)
Samples	None	100	1 - 1000	Determines the number of sensor readings taken into account in a 'sliding-window' averaging process. This will normally be set to correspond with some multiple of the rotational period of the mixer, multiplied by 10. The value of 100 therefore corresponds to 10 seconds.
+dV Coarse	Volts	0.03	0.01 - 10.00	Maximum positive voltage change allowed between successive sensor readings with coarse filter enabled.
-dV Coarse	Volts	0.06	0.01 - 10.00	Maximum negative voltage change allowed between successive sensor readings with coarse filter enabled.
+dV Fine	Volts	0.01	0.01 - 10.00	Maximum positive voltage change allowed between successive sensor readings with fine filter enabled.
-dV Fine	Volts	0.04	0.01 - 10.00	Maximum negative voltage change allowed between successive sensor readings with fine filter enabled.
Minimum volts	Volts	0.5	0.0 - 10.0	Minimum input voltage accepted from the sensor before a Sensor Fault alarm is triggered.
Maximum volts	Volts	11.0	1.0 - 12.0	Maximum input voltage accepted from the sensor before a Sensor Fault alarm is triggered.
Sensitivity	mV	10	1 - 10000	When sensor type is set to 3, this sets the maximum allowed deviation in the sensor input voltage over the last 0.1 second. If the deviation is outside this limit, the sensor reading is ignored.
Simulation mode	None	0	0,1	The system contains a section of signal from a Hydro-Mix sensor installed in a 'pan' mixer. When set to 1, the real sensor input is ignored and this internal waveform is used instead. This has been provided for demonstration and teaching purposes to allow users to gain familiarity with the effects of the sensor set-up parameters.
Input time-out	s	5	1 - 100	Causes an alarm to be issued if the moisture reading is not updated due to an erratic sensor reading (sensor type 3) or missing synchronisation pulse (sensor type 2). This value should not exceed the Auto-Track time in the mixer control menu.
External sync menu	-	-	-	Provides access to a series of timers that can be used to time sensor readings from an external synchronisation input.

## 7.5 Water control set-up

Parameter	Units	Default	Range	Description
Water mode	None	Metered	Metered, Timed, Negative weigh	Determines how the water is measured into the mixer
Water flow per pulse	Litre	1.00	0.01 - 10.00	The quantity of water measured by each pulse of the water meter.
Water meter time-out	s	5.00	1 - 10	If no pulses are received within this time after opening a water valve, the system will trigger an alarm.
Fine delivery	L	0.0	0.0 – 1000.0	If set to a non-zero value, the Coarse Water valve will be brought into use to deliver water in excess of the figure entered. If set to zero, then all the water will be delivered through the fine valve.
Fine in-flight	L	0.0	0.0 - 100.0	Fine water valve in-flight compensation value.
Coarse in-flight	L	0.0	0.0 - 100.0	Coarse water valve in-flight compensation value.
Fine flow rate	L/s	0.1	0.1 - 10.0	For timed water delivery, determines the flow rate through the fine water valve.
Coarse flow rate	L/s	1.0	0.1 - 100.0	For timed water delivery, determines the flow rate through the coarse water valve.
Settling time	s	1	1 - 10	Allows time for the water valves to close. Any water delivery measured after this time will be classed as a water leak.
Valve leak alarm	L	2.0	1.0 - 10.0	If a leakage of water exceeds this amount in any mix cycle then an alarm will be triggered.
Water scale X1	%fsd	0.0	0.0 - 100.0	Water weighed raw input value corresponding to weight Y1 Kg below.
Water scale Y1	Kg	0.0	0.0 - 999.9	Weight of water scale corresponding to X1 input above.
Water scale X2	%fsd	100.0	0.0 - 100.0	Water weighed raw input value corresponding to weight Y2 Kg below.
Water scale Y2	Kg	200.0	0.0 - 999.9	Weight of water scale corresponding to X2 input above.
Water scale fill level	Kg	100.0	10.0 - 999.9	Level to which water scale is filled between mix cycles.

## 7.6 Analogue output set-up

A 0-10V analogue output is available for re-transmitting the current moisture value to an external system.

This menu configures the analogue output operating parameters.

Parameter	Units	Default	Range	Description
Minimum	%	0.00	0.00 - 100.00	Sets the moisture value corresponding to a 0V output.
Maximum	%	20.00	1.00 - 100.00	Sets the moisture value corresponding to a 10V output.
Calibrate	%	20.00	0.00 - 100.00	Forces this value onto the output as scaled by Minimum and Maximum settings when Calibrate is chosen as the output variable. This can be used to calibrate an external system.
Output variable	None	Now	Now, Volts, Calibrate Unscaled	Determines which variable is directed to the analogue output as follows: <u>Now</u> The current moisture value as displayed on the status display. <u>Volts</u> The rate-limited version of the sensor voltage for diagnostic purposes. <u>Calibrate</u> The moisture value set in the Calibrate parameter above. <u>Unscaled</u> The unscaled input reading from the sensor.

## 7.7 Alarms set-up

This menu is used to configure the available alarms:

Alarm name	Default setting	Description
Cement time-out	With siren	The Cement Done signal was not received in response to a Cement Call.
Admix 1 time-out	With siren	The Admix 1 Done signal was not received in response to an Admix 1 Call.
Admix 2 time-out	With siren	The Admix 2 Done signal was not received in response to an Admix 2 Call.
Mix cycle aborted	Silent	The current mix cycle was reset before it completed. This may have been either by the operator or by the Cycle Reset input.
No water required	With siren	At the end of the dry-mix time, the system determined that no additional water was needed.

*(continued)*

Alarm name	Default setting	Description
Reduced Admix 1 rinse	With siren	The system determined that insufficient water was available to provide the requested Admix 1 rinse. The Admix 1 delivery system should be checked to ensure that it has all been dispensed.
No Admix 1 rinse	With siren	No water was available to provide an Admix 1 rinse.
Mix too wet	With siren	At the end of the mix cycle, the mix was too wet compared with the target set in the recipe. This check only occurs in automatic water control.
Mix too wet - accepted	Silent	The operator accepted a wet mix. This would have forced the cycle to complete normally.
Mix too wet - rejected	Silent	The operator rejected a wet mix. This would have forced the cycle to complete with a mix error condition.
Mix too dry	With siren	At the end of the mix cycle, the mix was too dry compared with the target set. This check only occurs in automatic water control.
Mix too dry - accepted	Silent	The operator accepted a dry mix. This would have forced the cycle to complete normally.
Mix too dry - rejected	Silent	The operator rejected a dry mix. This would have forced the cycle to complete with a mix error condition.
Sensor fault	With siren	The input from the sensor was outside the pre-programmed allowed input range. This may indicate a faulty sensor or cable.
Sensor input time-out	With siren	The input value from the sensor was not updated within the time specified in Input time-out in the Sensor set-up menu.
Water meter/valve failure	With siren	No pulses were received from the water meter when the water valves were opened.
Leaking water valve(s)	With siren	The system registered water meter pulses when the valves were closed. The water system should be checked under these fault conditions as such a problem will lead to wet mixes.
Auto water limit exceeded	With siren	The system calculated a water requirement, which exceeded the limit programmed in the recipe.
Dry-Mix time limit	With siren	The system was unable to obtain a stable moisture reading during the dry-mix phase, even after extending the mix cycle by the time specified in <i>Mix extension time</i> parameter. The system reverted to <i>pre-set water</i> addition for the remainder of the cycle.

This chapter describes the various display pages available on the Hydro Control IV.

Some of the displays can be obtained directly from the main menu while others are displayed by pressing the relevant soft key when available on the screen.

**Note:** Some displays such as the language translation check and sensor capture displays will not be available unless you have logged in with the appropriate user code.

## 8.1 Status display

Select by pressing soft key  when available on screen.

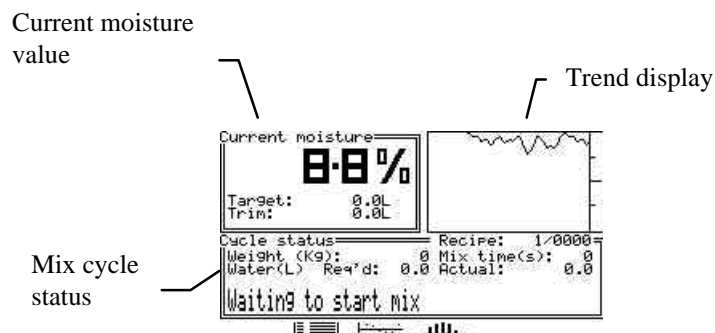

This display shows the current mix cycle status and moisture reading. It is the normal operating display for the system and is the default display when the unit is switched on. Note that some of the values shown are only valid during a mixing cycle and will generally show zero between cycles.

### Current moisture value

This shows the current moisture content as indicated by the Hydro-Mix sensor according to sensor calibration values stored in the currently selected recipe.

The display also shows the water target for the current cycle either as a percentage (automatic water mode) or as a volume (preset water mode).

### Trend display

This graphical display indicates how the moisture reading from the sensor is changing with time. The default setting is for the display to update every 1s. This can be altered by adjusting the parameter "trend interval" in the sensor set-up menu, (see Chapter 6 "Running the mix cycle" for more details).

### Mix cycle status

The lower section of the display shows some key status information about the current mixing cycle such as weights, times and water requirements. A status message describes what the system is doing at any time.

## 8.2 Data logging displays

The results of the most recent 100 mix cycles are stored by the Hydro Control IV and can viewed in several ways as described below

### Mix log display

Select by pressing soft key  when available on screen.

Recipe	Batch (kg)	Target (%/L)	Actual (L)	DRY (%)	FINAL (%)
1/0010	200	0.0%	0.0	0.0	0.0
1/0011	200	0.0%	0.0	0.0	0.0
1/0012	200	0.0%	0.0	0.0	0.0
1/0013	200	0.0%	0.0	0.0	0.0
1/0014	200	0.0%	0.0	0.0	0.0
1/0015	200	0.0%	0.0	0.0	0.0
1/0016	200	0.0%	0.0	0.0	0.0
1/0017	200	0.0%	0.0	0.0	0.0
1/0018	200	0.0%	0.0	0.0	0.0
1/0019	200	0.0%	0.0	0.0	0.0
1/0020	200	0.0%	0.0	0.0	0.0
1/0021	200	0.0%	0.0	0.0	0.0

The mix log display shows the results of the most recent 100 mix cycles (or less if 100 cycles have not been completed) in tabular form.

The display contains several pages of information showing all of the data logged during each mix cycle. The initial display shows the moisture content results at the start and end of the mix cycle.

Press  to view more pages showing information on the water addition, mixing times and any faults.

The headings from the mix log display are described in the table below:

Heading	Description
Recipe	Recipe number (RRR) and batch number (BBBB) in format RRR/BBBB.
Batch (kg)	Dry weight of ingredients in mix.
Target (%/L)	Water target in litres for preset water or % for automatic mode.
Actual (L)	Total water added to mix between end of dry mix phase and end of wet mix phase including any overruns or manual additions.
DRY (%)	Moisture reading at end of dry mix period.
FINAL (%)	Moisture reading at end of wet mix period. If no final value was available due to the mix cycle being terminated abnormally this will display as '?????'
Water / Cement	Water/cement ratio based on final water % and cement weight given in recipe. This figure is only meaningful if the recipe has been calibrated in an absolute % mode.
Trim (L)	The quantity of water added or removed from the recipe value by the operator.
Error (L)	The quantity of water added to the mix as a result of overrun or leaking water valves. Non-zero values here indicate problems with the system which cannot be compensated for automatically and need further investigation.
Hand (L)	The quantity of water added by the operator in hand mode during the cycle.
Dry-Mix (s)	The dry mixing time used.
Wet-1(s)	The standard or first wet mixing time used.

Heading	Description
Wet-2(s)	Second wet mixing time, if using two-point water addition.
Total (s)	The total mixing time between <i>Start-mix</i> and <i>Mix complete</i> signals.
Cement fault	Failed to control the cement call as configured.
Admix 1 fault	Failed to control the Admix 1 call as configured.
Admix 2 fault	Failed to control the Admix 2 call as configured.
Reject mix	The mix was out of specification and rejected by the operator.
I/P-1	Unscaled input value read from sensor at end of dry-mix period.
I/P-2	Unscaled input value read from sensor at end of an inserted wet-mix period (mix set-up cycles only).
I/P-3	Unscaled input value read from sensor at end of wet-mix period.
DM1-2	Relative change in moisture content induced by adding water between end of dry-mix period and end of inserted wet-mix period (mix set-up cycles only).
DM1-3	Relative change in moisture content induced by adding water between end of dry-mix period and end of wet-mix period.

### Error trend display

Select by pressing soft key  when available on screen.

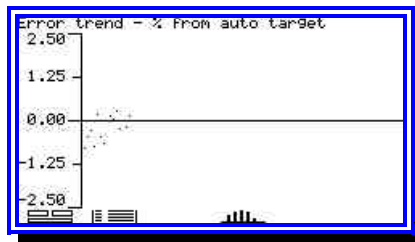

This displays the contents of the mix log as an error trend graph showing the difference between required and actual final moisture content.

For mixes terminated normally, this display shows the deviation from the auto % target with time for up to 100 mix cycles, starting with the oldest mix in the log. This can be used to spot trends in the deviation and thereby help to avoid problems.

Ideally the display will show an even scatter of results either side of the centre line with most of the results lying within the required mixing tolerance. Any deviation from this indicates a possible problem. In particular, it can be used to identify problems that appear progressively, for example a build-up of old material in the mixer covering the face of the sensor.

Each dot on the display represents the result of one mix cycle in terms of its deviation from the auto target for that particular mix cycle.

The vertical axis can be scaled if required using the parameter “Error bandwidth” in the mix log set-up menu.



## Error distribution display

Select by pressing soft key  when available on screen.

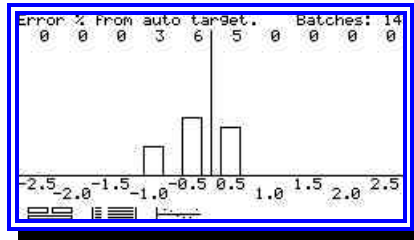

This displays the contents of the mix log as an error distribution graph with tolerance bands set by the user.

For mixes terminated normally, this display shows the deviation from the auto % target either on a current recipe basis or using the entire contents of the mix log, as set up in the parameter “analysis by recipe” in the mix log set-up menu. If “analysis by recipe” is set to 0 then the display shows the entire mix log. If it is set to 1 then the display shows the current recipe only.

Ideally the display will show an even distribution around the centre with a peak in the middle. Any deviation from this pattern indicates a possible problem. For example, a peak that is offset from the centre line normally indicates a calibration-offset error that might be corrected by adjusting the “water trim” parameter in the recipe database.

The error distribution graph can therefore be used to identify the nature of a calibration problem and other general information about the performance of the system.

Each vertical bar represents the number of mix cycles whose deviation from the auto target was within the range indicated.

The tolerance bands can be adjusted using the parameter “error bandwidth” in the mix log set-up menu.

### 8.3 Diagnostic display pages

The Hydro Control IV contains several displays that are used for diagnostic purposes and are accessed directly from the Main Menu.

#### Sensor diagnostic

Select by pressing

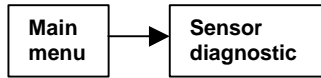

This display gives information about the current sensor readings in engineering terms.

#### I/O diagnostic

Select by pressing

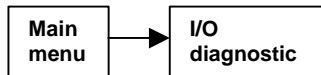

This display shows the status of the system input/output signals.

#### RS485 diagnostic

Select by pressing

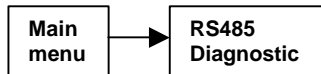

This display shows the transactions between the RS485 communications link and the input/output unit(s).

It is used to verify that the RS485 link is operating normally with few (if any) communications errors. An error count that increases by more than a few counts per hour should be investigated. At system start up there may be a few errors whilst the system synchronises itself.

### RS232 diagnostic

Select by pressing

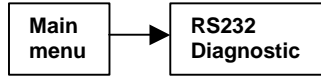

This display shows the transactions taking place on the RS232 computer link.

It is used to verify the data being transmitted to the Hydro Control IV by an external system.

### Language translation check

Select by pressing



This display shows the English string and its foreign language translation, one string at a time, for diagnostic purposes.

## 8.4 Sensor capture display

The Hydro Control IV has the facility to capture and store high-resolution sensor input data for display purposes. This can only be done provided you have logged in with the correct user code.

### Recording and viewing sensor data

Select by pressing

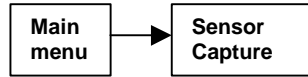

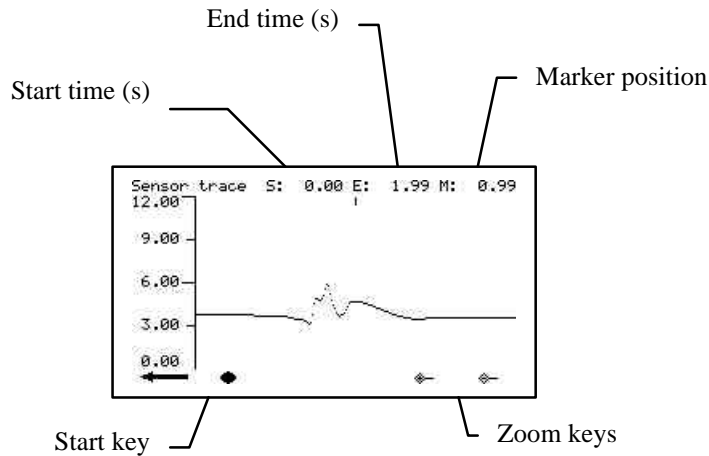

and press soft key  to begin capturing data.



This display shows the type of signal being produced by the Hydro-Mix sensor and is used to establish the sensor filtering parameters set up during installation and commissioning.

The sensor input is sampled 100 times per second and, once the sensor capture option is started, the display will capture data for about 240 seconds.

The top line of the display indicates the start and end times in seconds from when you pressed . The digipot can be used to position a marker at a particular point on the trace. This makes it possible to perform accurate measurements between significant features of the signal during system commissioning.

The  and  keys can be used to increase or decrease the zoom level so that the time period shown is either 2, 10, 60, 120 or 240 seconds. For example, the trace above looks quite different when viewed over a period of 120 seconds:

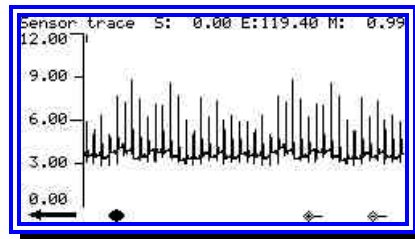

At anything other than maximum zoom level, only certain points can be plotted due to a fixed display resolution. In this case, each horizontal point is drawn as a vertical line between the minimum and maximum values in any group of points. This gives an overview of the extent of signal excursions at low zoom levels.

When using certain types of sensor signal processing (as selected by "type" in Sensor set-up menu) the capture display will indicate the positions where the sensor reading is being used. This permits the correct sensor input parameters to be established during commissioning.

The y-axis may be scaled by pressing  from the sensor capture display. The maximum and minimum voltages displayed can be set from the subsequent screen.

Once started, the capture of data is performed in the background and so it is not necessary to display this page continuously.

### Sensor update markers

In some applications, the readings from the sensor are taken at specific times to avoid interference from sources such as air pockets or mixer blades that introduce unwanted noise on the mixer signal. The large spikes in the image above are an example of such noise.

The Hydro Control IV includes several different signal processing methods for filtering this noise and the sensor capture display can be used to show the results of applying these filters (see Chapter 10 "System commissioning" for more information on filtering the sensor signal).

For example, using the Sensor Type 3 filtering option on the sample waveform above gives the following 10-second duration display:

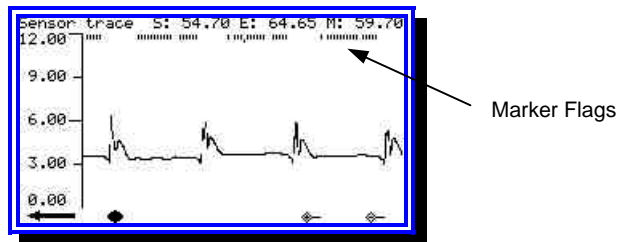

In this case, the system indicates the precise point of taking sensor readings with marker flags, showing the effect of the Type 3 filter at eliminating the unwanted noise spikes.

Reducing the "sensitivity" parameter in the sensor set-up menu from 10mV to 3mV causes fewer readings to be taken per cycle of the mixer and at times when the input signal contains smaller fluctuations:



The standard Hydro Control IV system is supplied for panel mounting with an operator terminal/front panel and an input/output module as separate units.

The Hydro Control IV can also be supplied in a steel wall-mounted enclosure incorporating both the operator terminal and input/output units together.

This chapter describes how to install the operator terminal and input/output unit, how to connect up the Hydro-mix sensor, the various inputs and outputs and the RS485 communications link. It also describes how to connect up the optional remote recipe selection unit.

**Note:** This chapter does not describe the connections to remote devices such as printers, batch controllers etc. via the RS232 communications port as they are covered in *Chapter 11, "Remote operation using RS232"*.

## 9.1 Unpacking the unit

Remove the Hydro Control IV unit from its packing and check for any transit damage or loose parts.

The items supplied with the unit will depend on your system configuration as follows:

<b>Standard unit:</b>	Operator terminal Input/output rack
<b>Wall mounted unit:</b>	Steel enclosure incorporating operator terminal and input/output rack
<b>Optional extra:</b>	Remote recipe selection unit
<b>Digital I/O modules (x8):</b>	Type as specified by customer

## 9.2 Safety Instructions

The Hydro Control IV has been designed in accordance with the recommendations of IEC 664 and has been supplied in a safe condition.

This instrument is suitable for indoor use only.



**If the equipment is used in a manner not specified by the manufacturer the protection provided by the equipment may be impaired.**

### Precautions

- Disconnect from voltage supply before the unit is opened for any adjustment, maintenance or repair work.
- Ensure that only fuses of the correct rating are fitted.

Ensure that the Hydro Control IV is mounted in an environment that will not cause electrical interference.

## Explanation of symbols and markings

It is important to understand the meaning of the various symbols and markings on the Hydro Control IV equipment as follows:

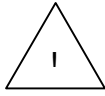

Caution, risk of electric shock



Caution, refer to accompanying documents

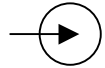

Input voltage

## Ventilation requirements

It is important to ensure that the wall-mounted enclosure has adequate ventilation and that the side vents are not restricted.

The recommended clearance for the sides of the enclosure is 100mm.

## Protection from lightning strikes

You should give some consideration to protecting the Hydronix installation from damage due to lightning and similar electrical disturbances.

Many installations will be in situations that are particularly prone to damage by lightning, for example:

- Tropical regions.
- Outdoor installations.
- Long cable runs between the sensor and instrumentation.
- Tall, electrically conductive constructions (e.g. aggregate bins).
- High value computer equipment connected.

Although the Hydro-Control is fitted with Opto-isolation on the sensor input, this will not prevent damage in all cases. Precautions should still be taken to avoid damage by lightning in areas where there is a known risk.

We would recommend the installation of suitable lightning barriers to all conductors in the sensor extension cable. Ideally, these would be fitted at both ends of this cable to protect both the Hydro-mix sensor and the Hydro Control IV plus any other equipment connected to it.

Please consult your Hydronix distributor for further information regarding lightning protection.

## 9.3 Installing the operator terminal

### Mounting in control panel

The operator terminal/front panel is mounted in a control panel (maximum thickness 10mm) as described below:

1. Cut out an aperture in the panel: **212mm high x 202mm wide**.
2. Remove the pair of mounting brackets from the operator terminal by releasing the screws and unhooking the brackets from the body of the unit.
3. Place the rubber-sealing gasket over the operator terminal and lay parallel to the fascia.
4. Insert the operator terminal through the prepared hole.
5. Re-fit the mounting brackets to the unit and tighten the screws to pull the fascia towards the control panel. Do not over-tighten as this may distort the fascia plate.

### Connecting the power supply

The operator terminal is connected to the power supply using a standard IEC power cord.

The voltage rating for the unit is indicated on the rear panel and can be adjusted to suit local voltages as follows:



**To prevent electric shock, disconnect the power cord before removing the cover.**

1. Remove the 4 screws securing the case to the front panel.
2. Remove the lid to reveal the mains transformer and power supply assembly.
3. Move the BROWN wire to select the appropriate mains voltage as indicated in Figure 5 opposite.
4. Refit the case and screws.
5. Indicate the new operating voltage on the rear panel using the labels supplied.

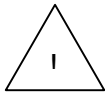

**Note: The operator terminal has a double-fused inlet.**

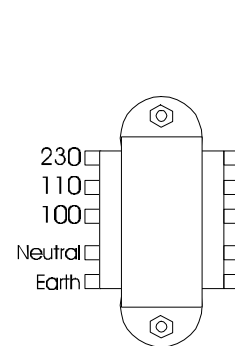

**Figure 5 - Mains transformer**



## 9.4 Installing the wall-mounted enclosure

### General layout

The wall-mounted enclosure for the Hydro-Control IV system is available as an optional extra from Hydronix.

This enclosure does **not** include space for the remote recipe selection unit, which, by definition, is intended for mounting remotely. However, it will house both the operator terminal and the input/output unit and therefore provides a convenient solution for adding the Hydro-Control IV to existing installations.

The external dimensions of the enclosure are shown in Figure 6.

The general layout of the back-plate is shown in Figure 7.

### Wiring connections

The internal wiring connections for the wall-mounted enclosure are shown in Figure 8.

This summarises the connections to the power supply, sensor, analogue output and RS232/RS485 communications ports.

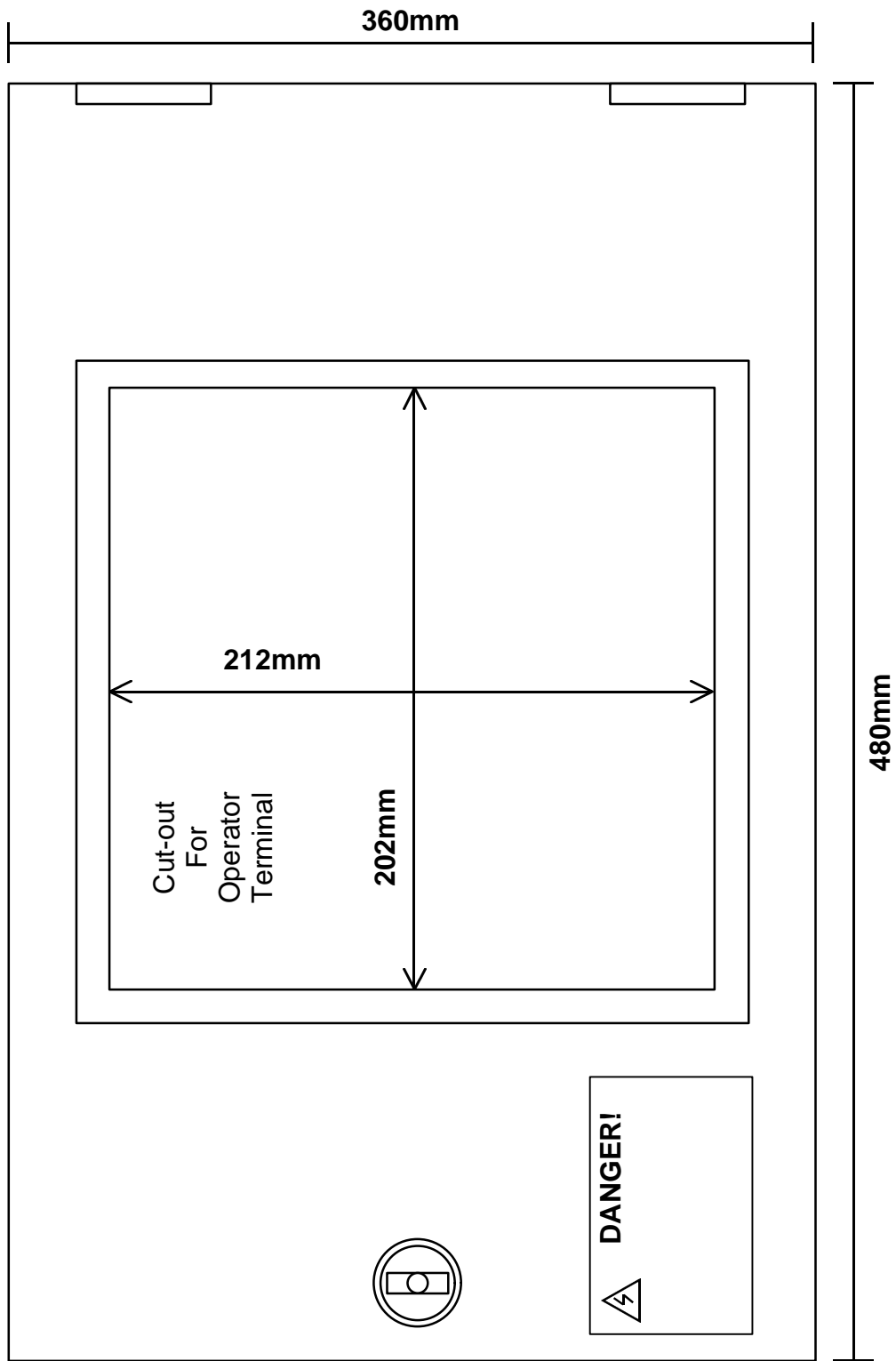
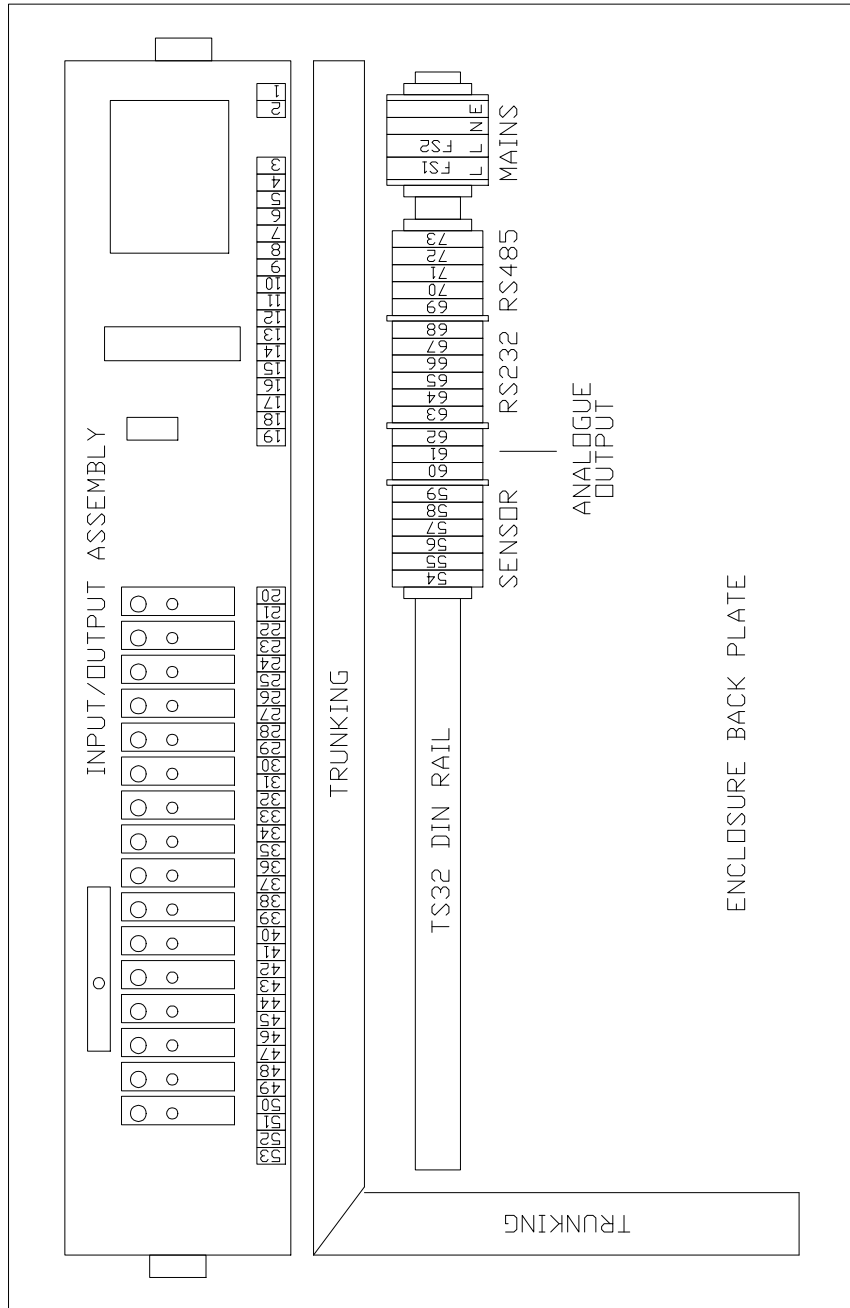

Figure 6 - Wall mounted enclosure dimensions



**Figure 7 - Wall mounted enclosure back-plate**

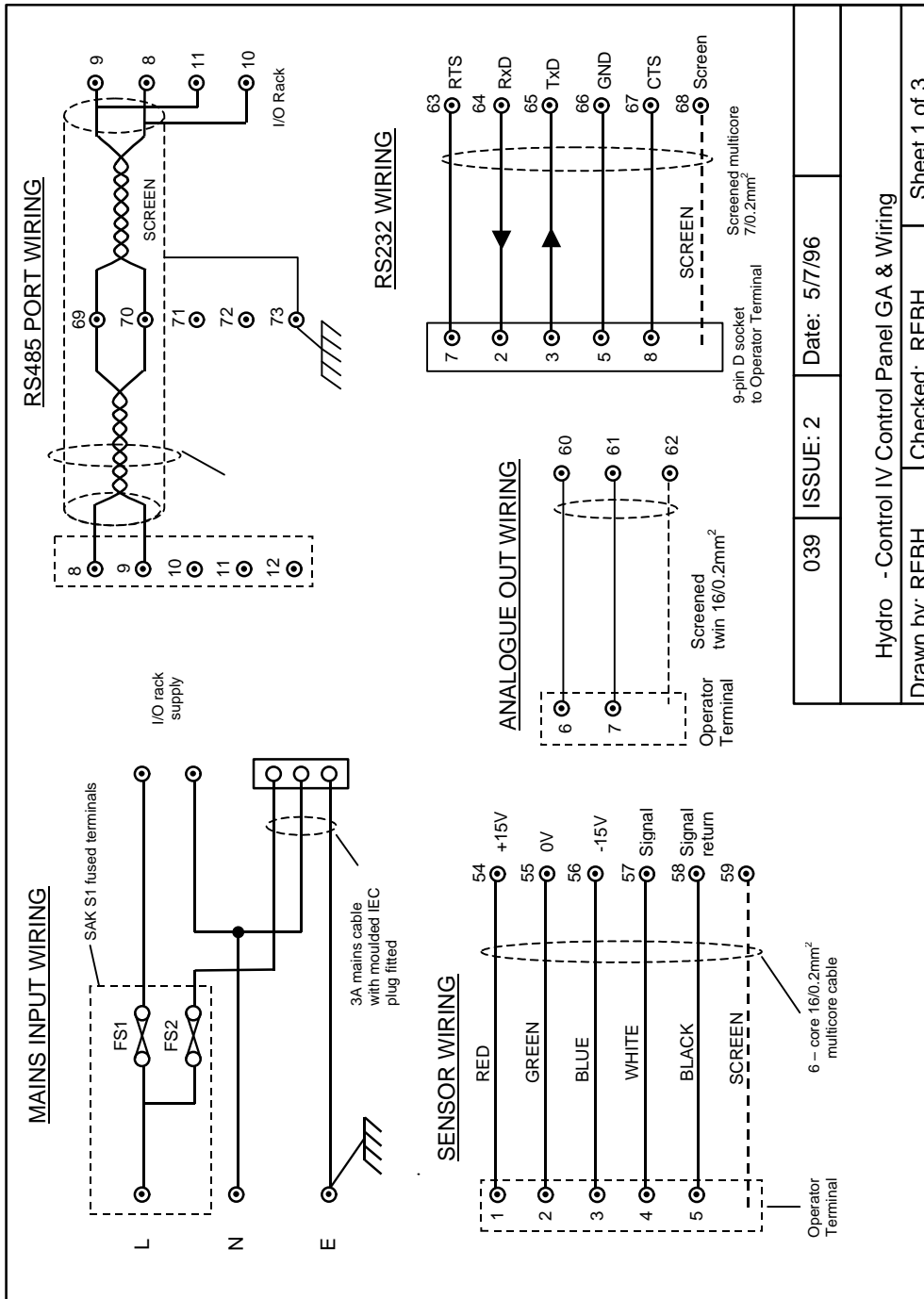

Figure 8 - Wall mounted enclosure wiring

## 9.5 Connecting the Hydro-mix sensor

### Connections to panel mount operator terminal

The Hydro-Mix sensor must be connected using a sensor extension cable made up from a suitable length of 5 or 6 core screened multi-core cable – 16/0.2mm (0.5mm<sup>2</sup>, 21 gauge).

The cable is terminated in screw-terminals on the rear panel of the operator terminal at one end, and in a 6-pin Bulgin connector at the other. This connector is supplied with the Hydro-Mix sensor and mates with a corresponding connector fitted to the sensor. The connections are shown in Figures 9 - 11.

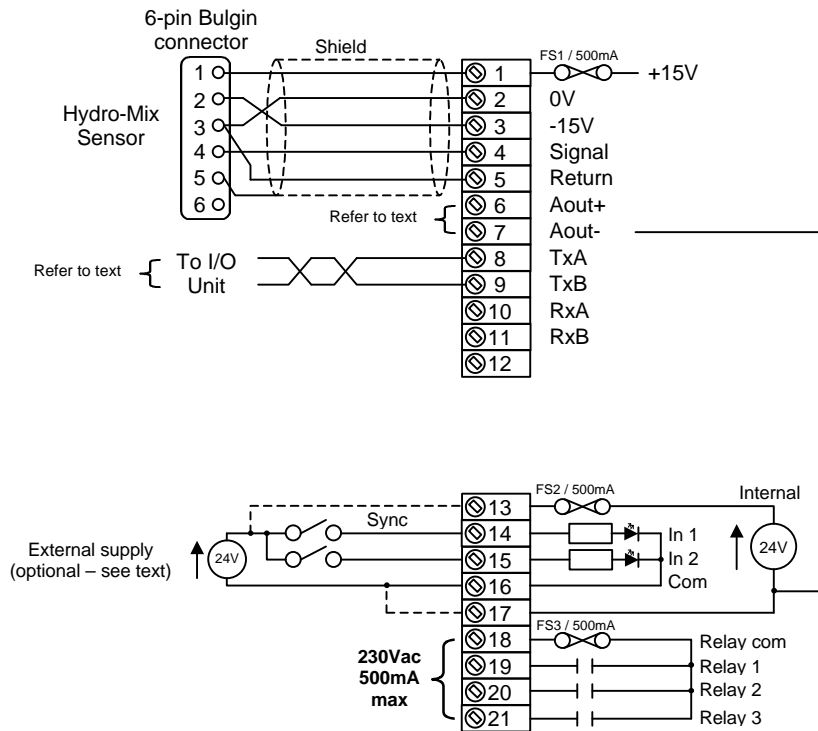

**Figure 9 – HM04 Sensor connections to panel mounted operator terminal**

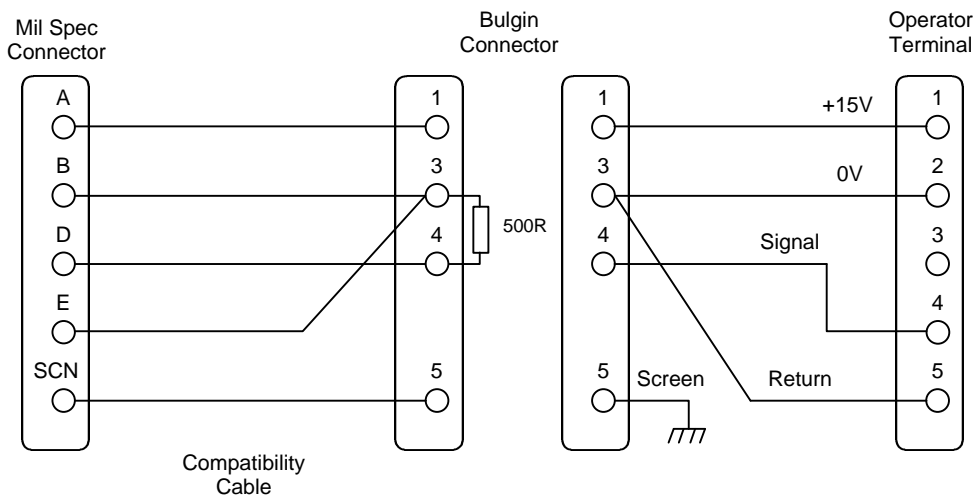

**Figure 10 - HM05 Sensor connections to panel mounted operator terminal**

## Connections to wall-mount enclosure

When using the wall-mounted enclosure, the operator terminal connections for the Hydro-Mix sensor are pre-wired to screw terminals on the back plate of the enclosure as shown in Figure 10

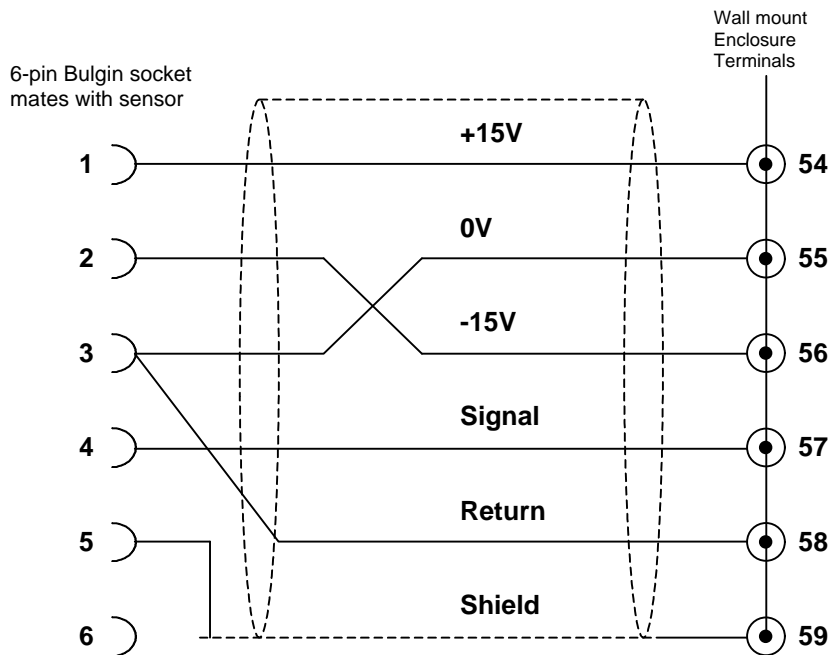

**Figure 11 - Sensor connections at wall-mounted enclosure**

(Note: Connection from Bulgin socket 2 to enclosure terminal 56 (-15V) is not required when using HM05 sensor.)

## Avoiding problems with sensor connections

**Electrical interference** Large motors and variable frequency drives create a large amount of electrical interference that may sometimes interfere with the signal from a Hydro-Mix sensor.

This interference may take the form of intermittent voltage spikes superimposed on the signal, or it may cause the signal to fluctuate. The latter is difficult to diagnose as it simply causes the probe to indicate that a material is wetter than it actually is.

The best way to see if a problem you have is caused by interference is to place material in front of the sensor and switch on the various motors and other equipment to see if they cause a deviation in the voltage from the sensor. An oscilloscope may be useful to spot voltage spikes, but remember that the oscilloscope itself may be picking up noise spikes.

**Ground loops** Ground loops are caused when the ground connections of different parts of an installation are at different potentials. If two grounds at different potentials are connected together by a piece of wire then a current will flow in the wire and noise will then be superimposed on the signal.

Avoiding problems due to electrical interference and ground loops is simply a matter of following a few simple guidelines:

Always connect the cable shield to a good ground. A large piece of metal is not always a good ground. A long metal spike driven into wet earth is probably a good ground.

Only connect the shield to ground at one end - leave the shield unconnected at the other. The Hydro-Mix sensor assumes that the mixer body is a good ground and hence the shield is terminated to the metal body of the sensor. If the mixer is not connected to a good ground then disconnect the shield in the Bulgin connector and ensure that the shield is properly grounded at the operator terminal end.

#### Synchronisation input

The signal from the Hydro-mix sensor can be filtered using one of three possible signal-processing methods designated as Sensor Type 1, 2 or 3 in the system. These options are fully described in *Chapter 10 "System commissioning" under section 10.6.*

If you decide to use Sensor Type 2 signal processing, then an external proximity switch must be connected to the Sync input shown in Figure 9. This proximity switch must be installed such that it will provide one pulse per revolution of the mixer.

The Operator terminal provides a 24Vdc supply for exciting devices such as switch contacts or proximity switches. However, the total current drawn from this supply must be limited to around 50mA.

If the internal power supply is used, follow the wiring connections shown with dotted lines at terminals 13 and 17 in Figure 9. Use of the internal supply is not recommended, however, because electrical isolation from the sensor will be lost and this may give rise to ground loop problems, especially if the analogue output connection is used as well.

Wherever possible, an external supply should be used, as this will maintain electrical isolation. In this case, the dotted line connections in Figure 9 should be omitted.

A typical specification for a suitable proximity switch is shown below:

Device type:	PNP (source type)
Voltage:	24Vdc
Quiescent current:	10mA
Switch current:	10mA

These proximity switches are available directly from Hydronix.

## 9.6 Installing the Input/Output unit

The Input/Output unit is the interface between the Hydro Control IV and your mixer control system. It consists of a number of digital inputs and outputs that are described later in this chapter.

The unit is suitable for mounting on standard 'top-hat' or TS32 section DIN-rail either within your control panel or in a separate wall-mounted enclosure available as an option from Hydronix.

### Standard input/output unit

The standard input/output unit accommodates up to 16 digital I/O channels plus a single analogue input for use with water weighing systems if required.

Figure 11 shows the general layout of the standard input/output unit.

The digital inputs/outputs consist of 16 single-channel plug-in modules that can operate at different voltages, making the Hydro Control IV capable of supporting a wide range of operating voltages around the world.

The appropriate plug-in modules and operating voltages are specified by the customer to suit their application when the order is placed with the Hydronix supplier.

The digital input/output modules are manufactured by OPTO-22 of Temecula, California USA and have several advantages:

- Each channel is independently isolated and may be operated at a different voltage if required.
- Output modules are capable of driving solenoid valves directly.
- Well-proven reliability.
- Easy to interface to.
- Status indication is provided for each channel.
- Universally available via worldwide distributors including your Hydronix supplier.

**Note:** Whichever control voltage is used, this must be provided externally by your equipment.

The Hydro-Control IV does not provide a power supply.

### Remote recipe selection unit

An additional input/output unit can be installed as an optional extra to provide a facility for remote selection of recipes when a remote communications device is not available.

The remote recipe selection unit is identical to the standard I/O unit with the exception of the plug-in modules since these are all input types. In addition, the settings for DIP switch S1 are different from the standard I/O unit.



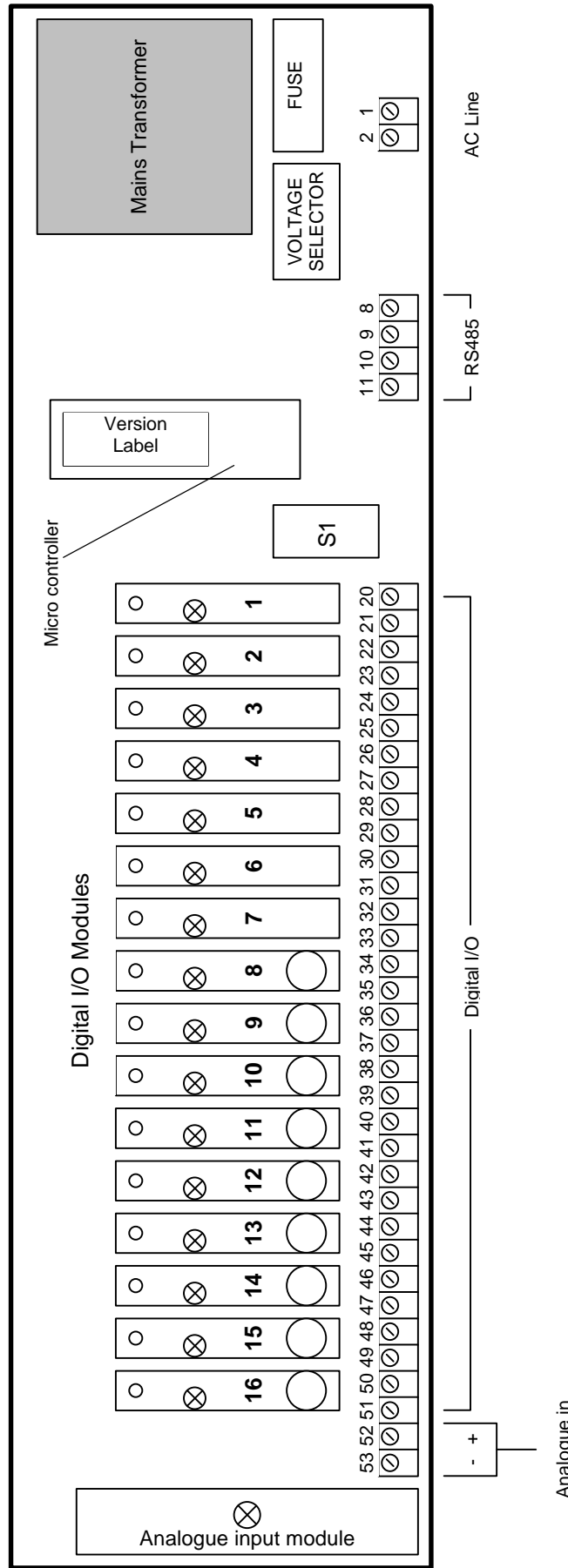

Figure 12 - Input / Output unit general layout

### Connecting the power supply

The input/output unit must be supplied with AC line power to terminals 1 and 2 at the voltage specified on the rating label (see Figure 11).

The AC line input must be protected with a time-delay (T) fuse rated at 100mA.

The input/output unit mains wiring generally consists of two insulated wires that must be terminated correctly and restrained from movement to prevent contact with other circuits in the event of broken wires etc.

The mains supply to the input/output unit must have a means of isolation such as a double pole circuit breaker.

### Connecting the I/O unit to the Operator terminal

The Operator terminal and Input/output unit(s) communicate using a RS485 communications link.

The input/output unit and optional remote recipe unit must be connected to the operator terminal using a screened twisted pair cable as shown in Figure 12.

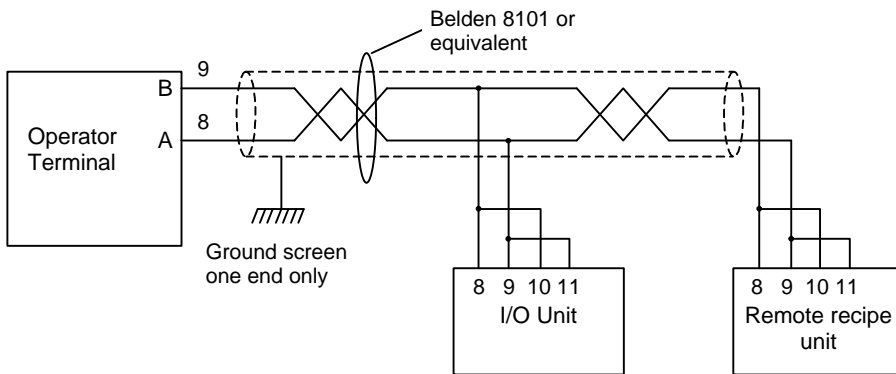

**Figure 13 - Input / Output unit connections via RS485 link**

Operator terminals with revision letter C or earlier could

be wired using either single or twin twisted pairs for a 2-wire or 4-wire interface respectively. The latter is not recommended for new installations and the single twisted pair cabling shown in Figure 12 should be used.

### RS485 termination

The twisted pair cable should be terminated at each end in a resistor equivalent to the characteristic impedance of the cable used - typically 100R/0.5W.

The operator interface terminal is supplied with termination resistors fitted internally and therefore nothing needs to be done here.

The input/output units are also fitted with line termination resistors and in installations that do not require the remote recipe unit, nothing else needs to be done.

When the remote recipe unit is installed, only one of the input/output units should be terminated and this should be electrically the most distant - the remote recipe unit in Figure 12.

To remove termination resistors on intermediate input/output units, locate jumper J1 on the circuit board and remove the push on jumper connector. J1 is located to the right of the micro controller chip above terminals 8 to 11.

## Digital inputs configuration

Modules labelled 1-7 on the input/output rack are configured as inputs and are described below:

No.	Name	Description
1	Water meter	Pulse counting input from water meter.
2	Start mix	Indicates that all dry ingredients are in the mixer and the Hydro Control IV should commence its automatic cycle. This may be either a pulse or maintained contact depending on how the system is configured.
3	Cycle reset	Resets the Hydro-Control sequence in the event of a non-recoverable sequence error and it is recommended that this should be activated prior to giving a Start Mix signal. If the Start Mix signal is configured as a pulse start, Cycle Reset must be used to terminate the Hydro-Control cycle. The signal is often derived from the mixer discharge door, although this is not totally foolproof and a separate signal is preferred.
4*	Cement done	Indicates that cement has been added in response to a Cement call signal (see below).
5*	Admix 1 done	Indicates that admix 1 has been added in response to a Admix 1 call signal (see below).
6*	Admix 2 done	Indicates that admix 2 has been added in response to a Admix 2 call signal (see below).
7*	Input 7	Spare input. Currently not used by the system.

## Digital outputs configuration

Modules labelled 8-16 on the input/output rack are configured as outputs and are described below:

No.	Name	Description
8*	Fill water	Request to open the water holding tank fill valve for water weighing applications.
9*	Coarse water	Request to open the coarse water valve. This output is optional.
10	Fine water	Request to open the fine water valve. If only one water delivery valve is fitted, then it should be connected here.
11*	Cement call	Request to discharge a pre-weighed quantity of cement into the mixer. The quantity of cement used is outside the scope of the Hydro-Control.
12*	Admix 1 call	Request to discharge a pre-set amount of admix to the mixer during the addition of water. A quantity of water can be held back to flush the admix system if required. The quantity of admix used is outside the scope of the Hydro-Control.
13*	Admix 2 call	Request to discharge a pre-set amount of admix to the mixer after the addition of water, but before the wet-mix period. The quantity of admix used is outside the scope of the Hydro-Control.
14	Mix Complete	Indicates that the Hydro-Control has completed its sequence. Used in conjunction with Mix OK/ERR, most interfacing requirements can be met without external relays.
15	Mix OK/ERR	Indicates that the Hydro-Control sequence has either terminated correctly or with a fault.
16	Alarm	Indicates that there is an unacknowledged alarm in the Hydro-Control system.

Signals marked with an asterisk (\*) are optional. It is not necessary for your system to use these outputs if you are not using the relevant facilities.

## Supported OPTO-22 input/output module types

OPTO-22 manufactures a wide range of different input/output modules for plugging into the input/output unit. The following are available directly from Hydronix Ltd:

### Digital input module types

Hydronix part	OPTO-22 part	Description
0413	G4SWIN	Simulation input module fitted with toggle switch. Ideal for demonstrations and testing purposes.
0401	G4IDC5	10-32VAC/VDC.
0400	G4IDC5K	2.5-16VDC - fast input module required for water meter pulse rates between 10Hz and 100Hz (1:1 mark:space ratio).
0402	G4IAC5	90-140VAC/VDC.
0403	G4IAC5A	180-280VAC/VDC.

### Digital output module types

Hydronix part	OPTO-22 part	Description
0414	G4SWOUT	Simulation output module fitted with toggle switch. Can be used for checking out field wiring to output devices. Switch rating 250VAC/VDC @ 3A.
0404	G4ODC5	5-60VDC @ 3A(45°C), 2A(70°C).
0405	G4OAC5	12-140VAC @ 3A(45°C), 2A(70°C).
0406	G4OAC5A	24-280VAC @ 3A(45°C), 2A(70°C).

### Analogue input module types

One of these may be fitted (at additional cost) if water weighing is required.

Hydronix part	OPTO-22 part	Description
0415	AD3	4-20mA
0416	AD6	0-5Vdc
0407	AD7	0-10Vdc
0417	AD9T	0-50mV, transformer isolated.

These modules provide 10-bit resolution. Full details of these modules are available on request.

More information on the OPTO – 22 Modules can be found on their website: - <http://www.opto22.com>

Field wiring connections to standard input/output unit

Figure 13 shows typical field wiring of the digital input/output signals into the I/O unit terminals.

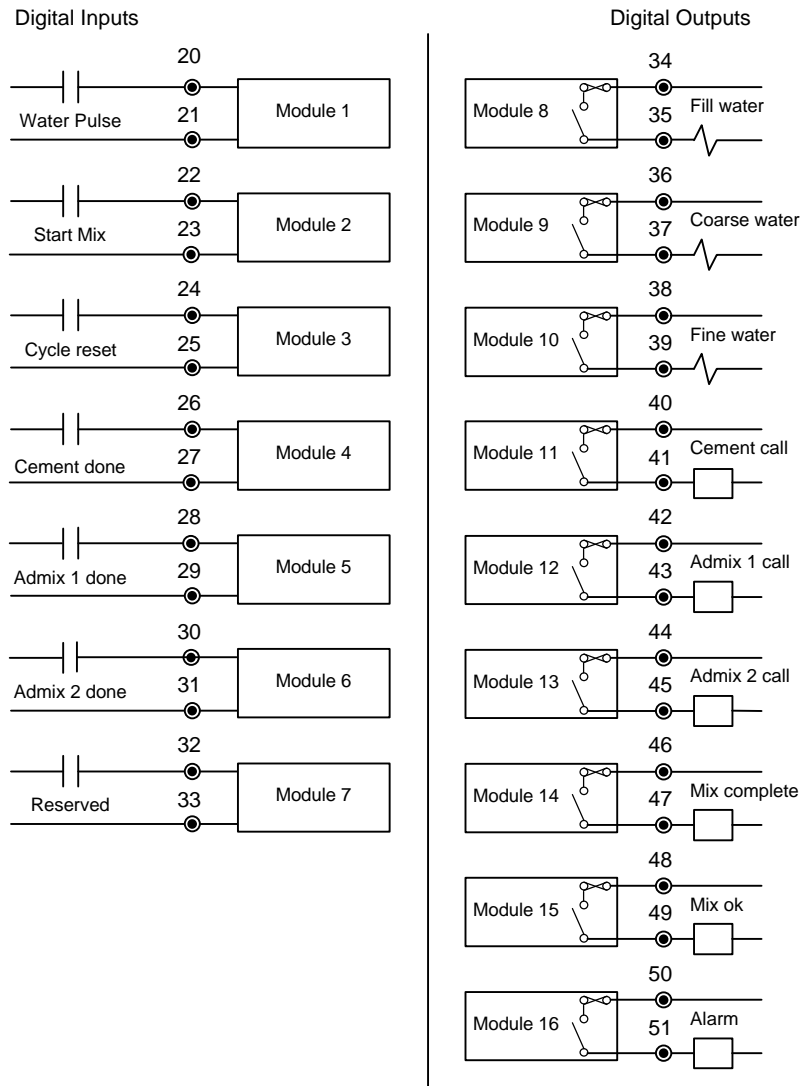
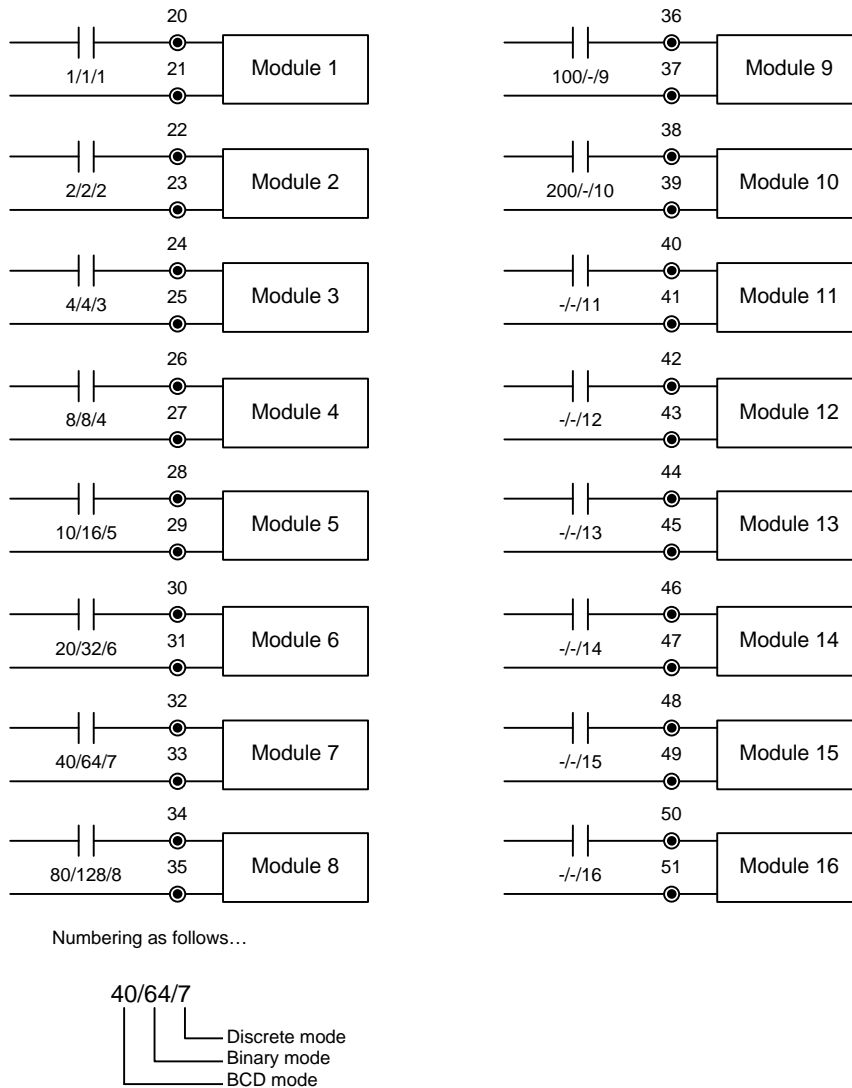

Figure 14 - Standard Input / Output unit field wiring

## Field wiring connections to remote recipe selection unit

The Hydro-Control IV system incorporates a facility for remote selection of operating recipe using digital inputs. This is shown in Figure 14 and takes the form of an additional input/output unit containing a selection of input modules that provide the recipe number.



**Figure 15 - Remote recipe unit field wiring**

The required recipe number may be represented in one of three ways:

- BCD** The recipe number is applied in Binary Coded Decimal form. This allows all recipes 1 through 200 to be selected using ten inputs.
- Binary** The recipe number is applied in binary form. This allows all recipes 1 through 200 to be selected using eight inputs.
- Discrete** Each input allows one recipe to be selected, allowing recipes 1 through 16 to be used.

The method used is configured from the front panel.

### Input/output unit switch settings

The input/output unit contains a set of eight DIP switches (Switch S1 in Figure 11) that must be set according to the intended operation of the unit as indicated in the table below:

Switch S1	1	2	3	4	5	6	7	8
Input/output unit	ON	OFF	OFF	OFF	ON	OFF	OFF	OFF
Remote recipe unit	OFF	ON	OFF	OFF	OFF	ON	OFF	OFF

### Relay outputs

The relay outputs on the Hydro Control IV are currently unused by the system. They are located on the operator terminal main circuit board (see *Figure 21* in *Chapter 13 "Maintenance"*).

## 9.7 Installation troubleshooting

The table below indicates some common causes of problems during initial installation of the system.

Symptom	Probable cause	Remedy
<i>Blank display</i>	Display contrast set incorrectly. No mains power.	Adjust display contrast. See <i>Chapter 2 "Operator terminal"</i> . Check mains supply and IEC inlet fuse. If fuse blows repeatedly contact your supplier.
<i>Sensor readings do not change.</i>	No sensor power supply.	Check voltage at terminals 1&2 of operator terminal. If not 15V then check internal fuse FS1 and replace if required. Ensure that wiring for sensor extension cable is correct. Check voltage at terminals 2&3 of operator terminal. If not -15V, then check that extension cable has been wired as per <i>Figure 9 "Sensor connections to operator terminal"</i> .
<i>Cannot see required menu item.</i>	Insufficient access rights	Log in by entering the correct user code for the required facility. See <i>Chapter 3 "Getting started"</i> .
<i>No serial communications</i>	Incorrect configuration	Check that the serial port has been enabled for the purpose you require.

Once the installation is complete, the Hydro Control IV system will need to be commissioned.

The following procedure takes you through the commissioning process to get the system fully operational and running in Automatic mode.

A checklist is provided in Appendix G to assist you during commissioning and to record progress.

## 10.1 Select language and units

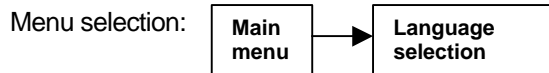

The Hydro Control IV will support the following languages:

- English
- French
- German
- Japanese
- Spanish
- Italian
- Dutch
- U.S. Customary
- Alphanumeric
- Polish

These can be selected by choosing “Language selection” from the Main Menu.

With any of the languages selected, the units will be in metric.

### Operation in US Customary units

If the option “US customary” is selected, the displays will be in English but all calculations and numeric functions will be in US customary units.

These calculations are not directly equivalent to those performed in other language settings and it is therefore not possible to switch between US Customary and other languages without some reconfiguration of the system.

For this reason it is necessary to enter a user code to change languages on the Hydro Control IV.



## 10.2 Check inputs/outputs

### Communications with input/output unit(s)

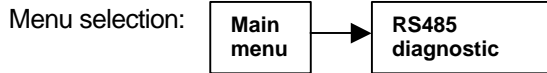

From the Main Menu select “RS485 diagnostic” to check that communications with the input/output unit are working correctly.

If there is a problem the display will show an error as in the example below:

```
RS485 diagnostic...
State variable          48
Error code              439
Error count             439
Good count
Tx buffer
!!X000069*
Rx buffer
1x00000000000001149*x00000000000001149*
```

The above display indicates a high error rate that, in this case, was caused by a part power down of the system.

The most common causes of errors are incorrect switch settings on the Input/output unit or incorrect wiring to the Operator terminal.

### Input/output operation

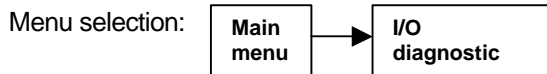

From the Main Menu select “I/O diagnostic” to check the operation of all the digital inputs to the system.

```
I/O diagnostic...
Water meter             0  Fill water           0
Start mix               0  Coarse water       0
Cycle reset            0  Fine water        0
Cement done            0  Cement call       0
Admix 1 done           0  Admix 1 call      0
Admix 2 done           0  Admix 2 call      0
Input 7 done           0  Mix complete      0
Input 7                0  Mix OK            0
                    0  Alarm             0

Water scale input (%FSD) 0.0
Water scale gross (kg)   0.0
```

**As inputs and outputs are called for, the value will change from 0 to 1. This can be checked against the input/output modules when the light switches on indicating the value is equal to 1.**

## 10.3 Check mixer control sequence

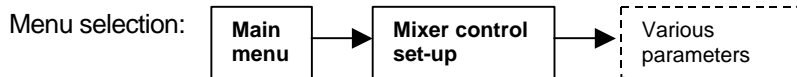

From the Main Menu select “Mixer control set-up” to check that the mixer control sequence is correctly configured to suit your application.

Some parameters in the “mixer control set-up” menu are associated with interface signals between the Hydro-Control IV and the control system. You must ensure that these parameters are set up to match the signalling requirements of the control system.

Refer to the “mixer control set-up” table in Chapter 7 “Configuration menus” for further details and to Appendix C for sequence diagrams.

### Remote recipe selection



If you are using the remote recipe selection facility, then the option “Recipe number source” in the mixer control set-up” menu must be configured to the signalling scheme required.

The system will only take note of the remote recipe setting at the start of the cycle when the display indicates “Reading recipe number”. At this time, the remote recipe setting will be displayed on the status page for verification.

### RS232 interface to batch computer

Menu selection:

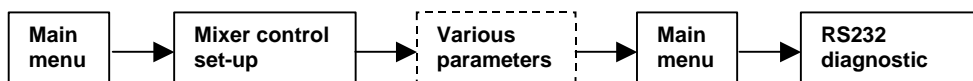

If you are using the RS232 serial interface to communicate with a batch computer, then the relevant parameters in the “mixer control set-up” menu must be configured according to the parameters that will be transmitted from the batch computer.

The available parameters are: Recipe number, dry weight, auto%, preset water and trim.

The RS232 port usage has to be set to Remote Link in order to utilise the serial interface.

Select “RS232 diagnostic” from the Main Menu to verify the operation of each message type individually.

## 10.4 Check water control sequence

From the Main Menu select “water control set-up” to check that the water control sequence is correctly configured to suit your application.

This section takes you step by step through each parameter in the “water control set-up” menu.

### Water mode

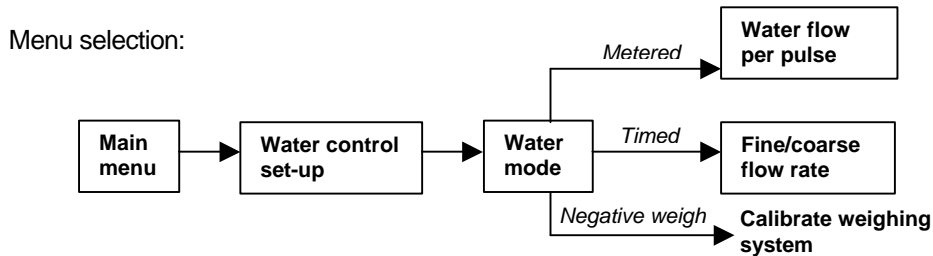

Select the option “water mode” and choose which method will be used for measuring the addition of water.

- Metered* Water is measured by counting pulses from a water meter. Enter the volume of water delivered per pulse of the meter in “Water flow per pulse”.
- Timed* Water is measured by assuming a constant flow rate. Measure the flow rate of water and enter it in “Fine flow rate” and “Coarse flow rate” as required.
- Negative weigh* Water is measured by weight as it flows out of a header tank. This mode needs calibration as described below.

### Water meter time-out

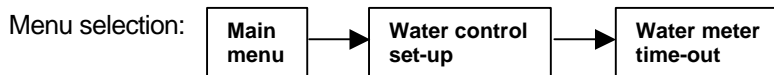

If the system is unable to detect an addition of water within a pre-set time, then it will generate an alarm. When this alarm is active, the valve outputs will be inhibited, thereby preventing flooding of the mixer.

Set this pre-set time in “water meter time-out” to suit your application (typically a few seconds).

Note that this value has no effect when the “Timed” method of measuring the addition of water is used.

### Fine delivery



If your system is fitted with both Coarse and Fine water valves, then you need to establish how much water is to be delivered through the fine water valve. This volume is set in “Fine delivery” and represents the final few seconds of water delivery, so it is dependent on the flow rate. Set this to a best guess and then adjust later to suit, since this will affect the overall mixing cycle time.

A combination of Coarse and Fine water valves will generally give best performance in terms of cycle time and accuracy.

If your system is only fitted with one valve it should be connected to the “Fine water valve” digital output and the “Fine delivery” parameter set to zero, resulting in all of the water being delivered through the fine water valve.

## Fine/coarse in-flight compensation values



When a water valve is instructed to close, there will be a certain quantity of water delivered after the command has been issued due to small delays in the operation of the valve. This quantity should be estimated for each valve and entered in “Fine in-flight” and “Coarse in-flight” as appropriate.

## Settling time

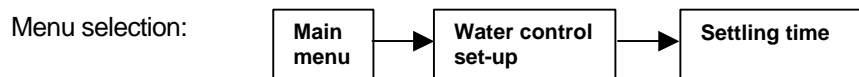

Whichever mode of water delivery is selected, some time must be allowed for the system to stabilise before a final water quantity reading is recorded. This time is set in the “settling time” parameter.

The value will depend on the operation time of the water valves together with any other delays or ‘run-on’ that might affect the water measurement.

## Valve leak alarm

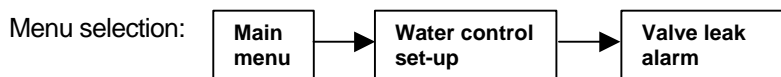

Any water that is measured after the settling time has expired will be treated as water added in error and will cause the Leaking water valve(s) alarm to trigger. Such erroneous addition of water will lead to inaccuracies and poor performance of the system and hence should be attended to promptly.

The amount of leaking water that is acceptable before the alarm occurs is set in “valve leak alarm”. You should set this value to be representative of the expected performance from the system. For example, if you are trying to control to within 1 or 2 litres, then the alarm should be set to trigger at (say) 2 litres.

## Calibrate water weighing system

### Water scale values

Menu selection:

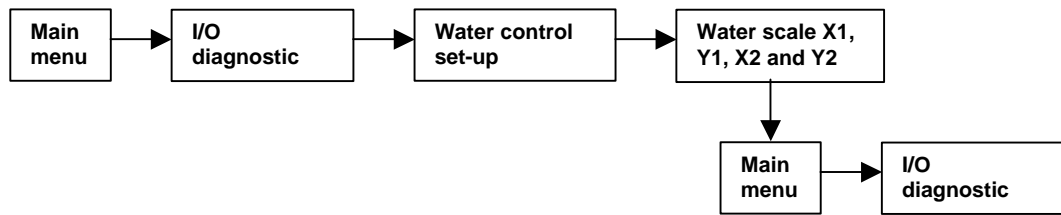

If you are using the “Negative Weigh” delivery method, then you will need to calibrate the weighing system to remove the tare weight of the holding tank.

To perform the calibration:

Task	Comment
From Main Menu select <b>I/O diagnostic</b>	Screen displays: 
<i>Empty the water holding tank.</i>	
<i>Record displayed value for “Water scale input (%FSD)” as <b>X1</b>.</i>	
Add a known weight of water to the tank and record this as <b>Y2</b> .	Choose a weight used in a typical cycle.
Record the new value at “Water scale input (%FSD)” as <b>X2</b> .	
Select <b>Water control set-up</b> menu and enter the values for X1, Y1, X2 and Y2 in “Water scale inputs” where <b>Y1 = 0.0</b>	The Hydro Control IV uses these values to calibrate the weighing system.
Return to Main Menu and select <b>I/O diagnostic</b> .	Display now shows the correct weight of water in the holding tank.

### Water scale fill level

Menu selection:



Finally, establish the initial weight of water that will be required in the holding tank before each mix cycle and enter it into “water scale fill level”. This value must exceed the maximum water requirement for any mix cycle so that it does not run out of water during the cycle.

Between cycles, the filling operation is indicated by a negative water value on the status display which increases toward zero as the holding tank fills. When the value reaches zero, the holding tank is at or above the initial fill level at which point the tare weight of the scale is recorded ready for the water addition.

*See also the control sequence diagram in Appendix C.*

## 10.5 Run system in Preset mode

Now that the initial set-up of the system has been completed, it is recommended that the system is run for several cycles in Preset mode.

This will verify if the interface between the batch controller and Hydro Control IV is operating correctly and that it is possible to run the mixer with the system using preset water addition.

This procedure establishes a fallback mode in the event of problems being encountered with setting up the sensor and will probably save time later.

To run the system in preset mode, a test recipe should be set up with the appropriate cycle times and other operating values.

## 10.6 Filtering the sensor signal

### Displaying the sensor signal

Menu selection:

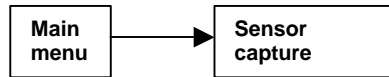

When pre-set mode is working correctly with realistic cycle times and batch quantities, you can begin to look at the readings from the sensor.

Use the “sensor capture” display to view the input signal from the moisture sensor whilst a batch of material is being processed. See *Chapter 8 “Sensor capture display”* for instructions on using this display.

The commonest application is probably a ‘turbo’ style static pan mixer. The input from this type of mixer is characterised by large spikes caused by voids in the mix as shown in the display below. Such a signal requires effective filtering before it can be used.

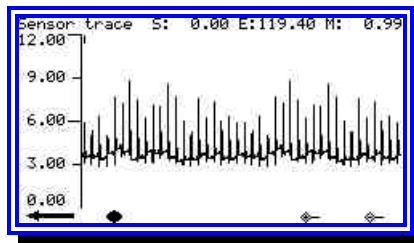

### Filtering options

Three filtering options can be applied to this type of mixer:

**Sensor Type 1** This option applies the rate-limiting filter only with no pre-processing of the input.

This method is generally quite effective, but where large voids are present in the sensor reading it can be inadequate.

**Sensor Type 2** This option applies an external synchronisation signal to one of the inputs on the back of the operator terminal. This is a very precise way of eliminating the interference but requires additional hardware in the form of a proximity switch.

This processing is applied to the input before the rate-limiting filter described above and consequently may be used in combination with the rate-limiting filter if required.

**Sensor Type 3** This option enables a specially designed algorithm to eliminate most of the spikes without affecting the response time of the system to any appreciable extent.

This algorithm looks for plateaux in the input signal and only takes readings when the signal is sufficiently stable, usually when there is good coverage of material over the Hydro-Mix sensor. However, if the mixer action is such that it produces several plateaux at different levels (corresponding perhaps to a variable thickness of material over the sensor) the algorithm is likely to produce a periodic ‘ripple’ in the moisture value which may be difficult to eliminate: Sensor Type 2 option would be a better solution under these conditions.

This processing is applied to the input before the rate-limiting filter described above and consequently may be used in combination with the rate-limiting filter if required.

## Signal processing examples

This section describes how to use the different filtering options and the effect they have on the sensor waveform.

The following displays have been produced from the built-in simulation waveform by varying the signal processing parameters in the “sensor set-up” menu.

### Raw unfiltered signal

Without any filtering applied at all, the moisture reading is very erratic and totally unsuitable for control:

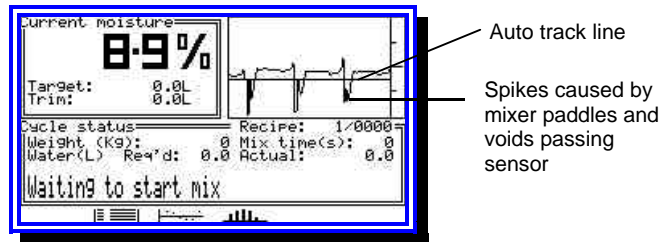

The values used to obtain this display were:

Parameter	Value
Trend interval	0.1
Trend lower limit	5.0
Trend upper limit	15.0
Type	1
Samples	1
+dV Coarse	10
-dV Coarse	10
+dV Fine	10
-dV Fine	10

As can be seen, the moisture value of 8.9% (also indicated by the Auto track line) is a good approximation, but the true value is higher as indicated by the flat tops in the signal.

The first thing to do is to eliminate the spikes in the waveform and several approaches can be used as described in the following examples.

### Sensor Type 1 example

In this example, the Sensor Type is set to 1 (default value) and the rate-limiting filter is applied.

#### Rate limiting filter

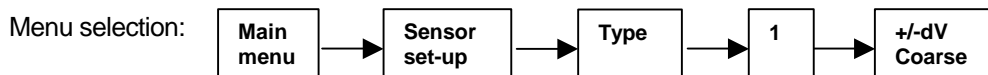

Apply the rate-limiting filter by adjusting the coarse dV values as follows:



Parameter	Value
Trend interval	0.1
Trend lower limit	5.0
Trend upper limit	15.0
Type	1
Samples	40
+dV Coarse	0.02
-dV Coarse	0.10

The effect of these values on the display is to eliminate most of the noise in the reading, but there are some undulations remaining as shown below:

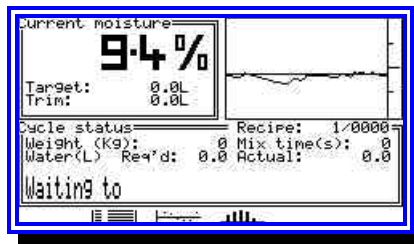

In practice, it is usually the **average** moisture value that is required for the material as it moves past the sensor. Greater accuracy will be obtained by increasing the number of samples. For example, increasing the number of samples to 75 gives a more stable signal:



Increasing the number of samples, however, will slow down the system response time and extend the mixing time, so aim to achieve a suitable compromise between tight water control and throughput.

### Fine filter

Menu selection:

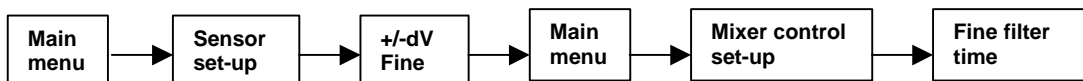

The fine filter can be used to achieve a stable reading close to the critical points in the cycle where calculations are performed. Reducing the coarse filter values below the practical minimum values given above will result in a very sluggish response. However, the fine filter settings can be reduced to 0.01V if required since they are only applied at certain times during the mix cycle.

To apply the fine filter, set the “+/-dV Fine” to the required values and set the “Fine filter time” to a non-zero value.

## Sensor Type 2 example

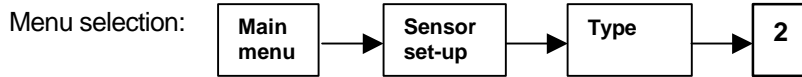

This filtering option should be considered if the sensor waveform contains several plateaux at different levels during one revolution of the mixer as shown in the display below. This is usually caused by the sensor seeing the effects of several mixing blades passing by, resulting in the material being laid over the sensor at different depths. In extreme cases this can cause the sensor head to be completely exposed.

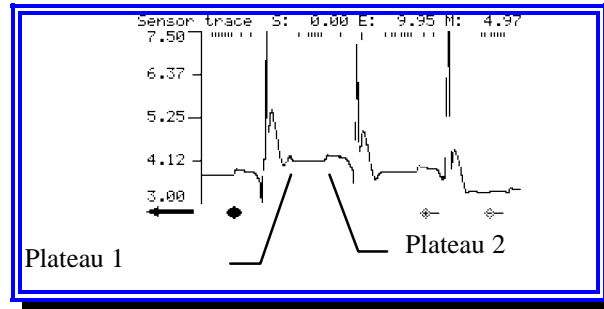

In this case the algorithm used is type 3 (see example below) and this is taking virtually all of its readings on plateau 1. However you can also see that a single reading is taken on plateau 2, which is probably erroneous. This can often be eliminated by varying the sensitivity parameter, but if not the type 2 approach should be considered as readings can then be programmed to occur at precise time intervals from the external synchronisation signal.

The different levels that can be seen between successive 'spikes' are caused by an in-homogeneous mix moving around the mixer. Usually these variations will reduce as the mix progresses and are a good indicator of mixer performance.

It should be noted that the type 2 algorithm is always likely to produce the best results in the shortest time, since other signal filtering (and associated delays) can often be eliminated.

To configure the system for sensor type 2 operation, proceed as follows...

- ⇒ Locate a suitable position for a proximity sensor in the mixer or on its associated drive mechanism. This should be capable of providing a single pulse per revolution of the mixer. For wiring information see *Chapter 9 "Installation"*.
- ⇒ Select sensor type 2 in the sensor set-up menu.

The proximity sensor provides an input from which you can 'time' the sensor readings. The timing for these readings is established by setting values in the *External sync* section of the *Sensor set-up* menu. The first timer value here specifies a delay in 1/100<sup>th</sup>s of a second from the proximity sensor input. The remaining nine values indicate where successive sensor readings are taken - again in 1/100<sup>th</sup>s of a second - allowing a total of up to ten readings per revolution to be specified. A value of zero in any of the timers will terminate the list.

- ⇒ Use the *Sensor capture* display facility to identify appropriate time intervals to take a reading, using the marker to measure the time intervals and set the list of timers accordingly.

Verify that the readings are being taken correctly by re-running the sensor capture.

### Sensor Type 3 example



In this example, Sensor Type 3 is selected in the sensor set-up menu and the signal-processing algorithm is applied to the same raw data used earlier:

Parameter	Value
Trend interval	0.1
Trend lower limit	5.0
Trend upper limit	15.0
Type	3
Samples	1
+dV Coarse	10
-dV Coarse	10
+dV Fine	10
-dV Fine	10
Sensitivity (mV)	10

In the display, the large spikes have been eliminated and the reading now changes in a step-like manner that is characteristic of the sensor type 3 algorithm.

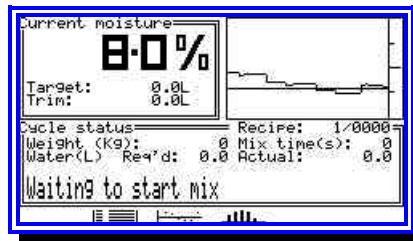

The corresponding sensor trace is as shown below where the steps correspond to the plateaux in the sensor voltage waveform.

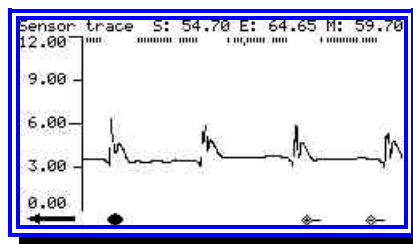

Reducing the sensitivity value may give an improvement but this is not always the case since different mixers may behave in different ways. It would also lead to fewer readings per revolution being taken and possibly none at all within the sensitivity limit, causing the “Sensor Input time-out” alarm to occur. You should aim for approximately 10 readings per revolution, using the markers on the sensor capture display to verify this.

With Sensor Type 3 selected, the sensor is responding to ‘flat’ or stable sections of the input waveform. If your waveform shows several different flat sections at different levels, this indicates that the sensor is covered by a variable thickness of material. In this case, the type 3 algorithm may not work reliably or may need combining with further filtering such as the “+/-dV” and “samples” parameters in the sensor set-up menu.

Ideally in this situation the sensor should be moved to a more suitable site in the mixer, or the blades of the mixer adjusted. If this is not possible, consider using Sensor Type 2 and fitting an external proximity switch to allow readings to be synchronised to a suitable point in the mixer rotation. Another possibility is to use the default Sensor Type 1 settings, although this might result in a longer mix cycle time due to the longer filter time constants required.

The Type 3 algorithm will generally produce a reading more quickly than Type 1 alone and it is quite effective at dealing with situations where the raw signal shows evidence of large voids.

## Recommended starting values for sensor set-up menu

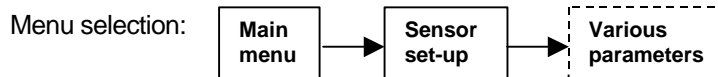

The table below gives some recommended starting values for the “Sensor set-up” parameters using the different filtering options. A description of each parameter can be found in *Chapter 7 “Configuration Tables”* which summarises all of the configuration menus.

Parameter	Type 1	Type 2	Type 3
Trend interval	0.5	0.5	0.5
Trend lower limit	0.00	0.00	0.00
Trend upper limit	15.0	15.0	15.0
Type	1	2	3
Samples **	100	25-75	25-75
+dV Coarse	0.02	1.00	1.00
-dV Coarse	0.05	1.00	1.00
+dV Fine	0.01	1.00	1.00
-dV Fine	0.04	1.00	1.00
Minimum volts	1.00	1.00	1.00
Maximum volts	11.0	11.0	11.0
Sensitivity	Any	Any	2 - 5
Simulation mode	0	0	0
Input time-out	Any	10	10

\*\* This value defines the ‘window’ over which the sensor readings are averaged.  
For example, 100 corresponds to 10.0 seconds.

## 10.7 Set up the Auto-track facility

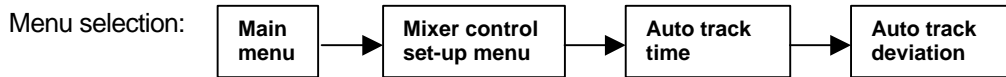

This facility is used to check when the material in the mixture has reached a stable and homogeneous condition.

During the mix cycle, the moisture content shown on the sensor trend display fluctuates because the batch material is inhomogeneous. As the cycle progresses, the fluctuations become smaller and the reading more stable until the mix becomes homogeneous,

When the Auto track facility is enabled, the Hydro Control IV detects when this homogeneous state has been achieved and displays a horizontal line through the sensor trend display. The Auto track line is generated only when the fluctuations fall within limits set in the **Auto track deviation** parameter.

### Auto-track deviation

This is the maximum permitted deviation on the moisture reading before it is regarded as stable.

It is set up in the “**mixer control set-up**” menu and a starting value of 0.10 is recommended.

**Note:** The Auto track facility is switched off if Auto track deviation is set to zero.

### Auto-track time

This value is the period of time for which the moisture value must be stable before the dry and wet mix cycles are ended.

It is set up in the “**mixer control set-up**” menu and a starting value of 10-15 seconds is recommended.

### Mix extension time

If the dry or wet mix times expire before the stable condition is reached, the time is extended by an amount set in the **mix extension time** parameter. If this time limit is exceeded during the dry mix cycle, an alarm will be triggered and the mixing cycle will be completed using the Preset water value for the recipe.

It is set up in the “**mixer control set-up**” menu and a starting value of 25-30 seconds is recommended.

Typical starting values for dry and wet mix times in a pan mixer would also be 25-30 seconds, although care must be taken not to make the mixing time too short; sufficient time should be allowed for any added water or materials to make contact with the sensor otherwise the cycle will finish too early.

## 10.8 Set the mix tolerances



The plus/minus tolerances are the acceptable tolerances at the end of the wet mix cycle before the mix is alarmed as “too wet or too dry”.

They are set up in the “recipe database” and tolerances of +/-0.5% will be acceptable, although some sites may require lower levels to be set.

Each time an automatic mixing cycle completes successfully and is within the set tolerances, the pre-set water value in the recipe is updated according to the actual water value used. The pre-set water value can thus be used as a fallback value if required and will generally provide a mix similar in consistency to the last known acceptable mix.

The system makes this judgement based on the tolerance properties set in each recipe. For the updating of the pre-set value to be effective, it is essential to keep the tolerance values in the recipes to realistic limits. The consequence of setting these too wide so that wet/dry mix alarms do not occur is that the pre-set water value can become unrepresentative leading to poor mixes when the fall-back facility is required.

## 10.9 Run system in Automatic water mode

After the system has been running satisfactorily in pre-set mode and the signal from the sensor looks reliable, you can then proceed to calibrate the recipe and switch to Automatic water addition mode.

This procedure is described in detail in *Chapter 6 “Calibration”*.

The behaviour of the system should then be observed over a period of time and minor adjustments made if necessary.

## 10.10 Record system configuration data

Now that the Hydro Control IV system has been fully commissioned, we recommend that you record all the values used during commissioning in the System Commissioning tables in Appendix G.

If a printer is fitted to the system, then any changes to the configuration will be recorded automatically whenever confirmation of a configuration change is made.

The Hydro Control IV working parameters are held in battery-backed CMOS memory with a predicted life of approximately 10 years at room temperature, although this lifetime is subject to operating conditions.

The Hydro Control IV can be connected to a remote device such as a printer or a programmable logic controller (PLC)/batch controller for remote operation via a RS232 interface.

This chapter describes how to set up the RS232 connections for these devices and the communications protocol required to carry out remote tasks.

## 11.1 RS232 connections on operator terminal

The Hydro Control IV operator terminal is fitted with a 9-pin D-type male connector and is connected to the remote device using the wiring shown in the table below:

Pin No.	Signal name	Description
2	RxD	Receive data. Input.
3	TxD	Transmit data. Output.
5	Gnd	Signal ground.
7	RTS	Request to send. Output. Permanently strapped 'active' internally.
8	CTS	Clear to send. Input. Not used in this application.

### Connections at wall mounted enclosure

If you are using the Hydronix wall mounted enclosure, then the RS232 connections will have been wired out to screw terminals for ease of use as shown below:

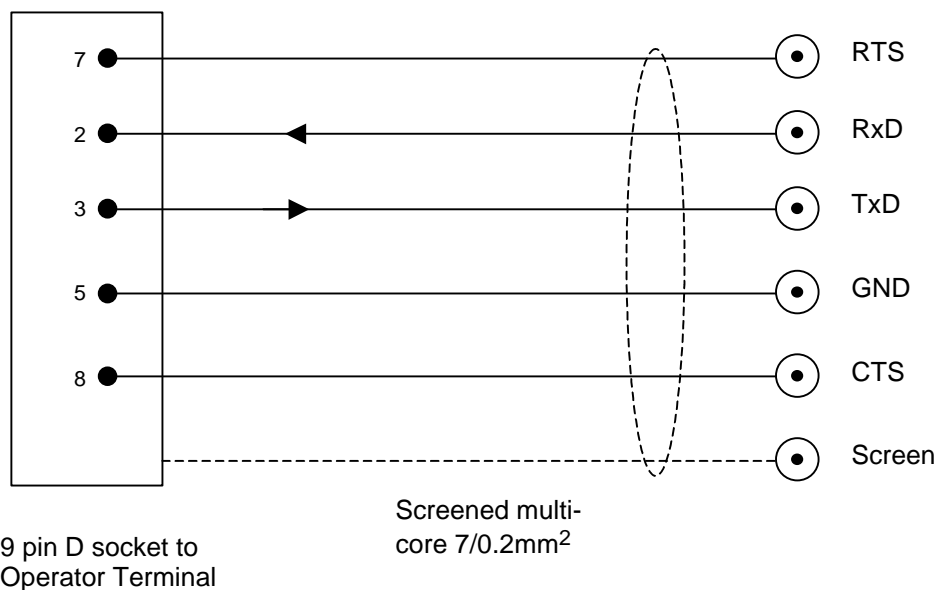
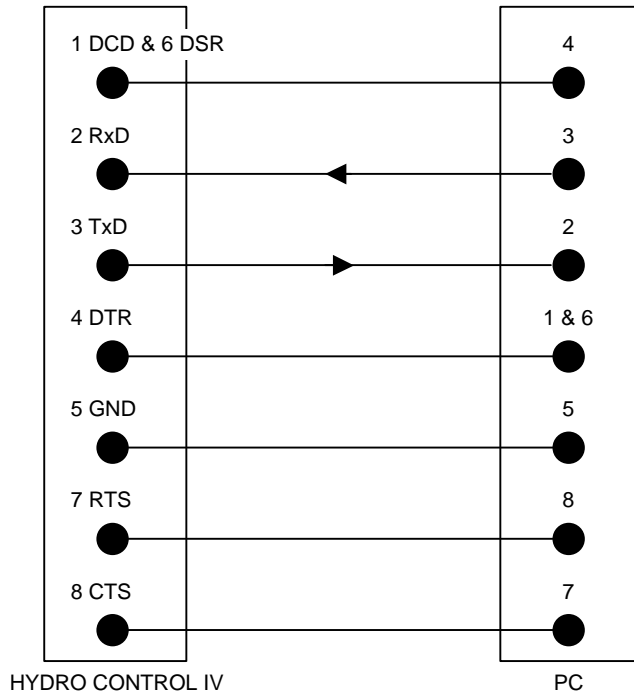

**Figure 16 - RS232 connections at wall-mounted enclosure**

## 11.2 Null modem cable connections

### 9-pin

The null modem cable connections using female 9-pin sockets are shown below:



**Figure 17 - Null modem connections (9-pin)**

### 9-pin to 25-pin

The null modem cable connections for a 9-pin socket to a 25-pin socket are shown below:

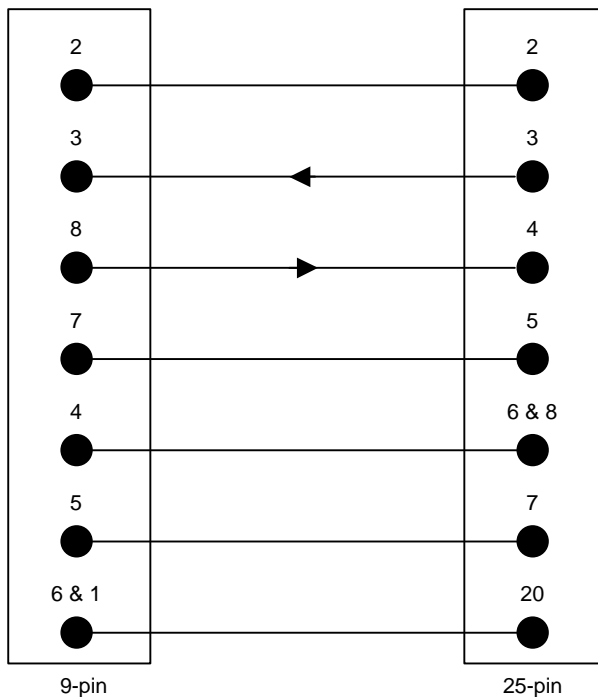

**Figure 18 - Null modem connections (9-pin to 25-pin)**



## 11.3 Connecting a printer

A standard serial printer may be connected to the Hydro Control IV for the production of reports using the RS232 connections shown in Figure 18 below.

To use the printer, the "Mixer Control set-up" menu **must** be configured so that the option "RS232 usage" is set to **Printer**.

9-pin

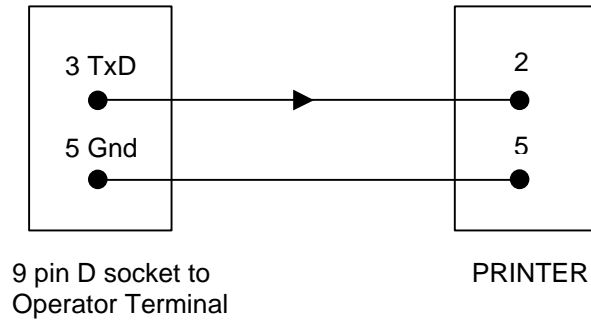

**Figure 19 - RS232 connections for printer**

The printer must be set to operate as follows:

Baud Rate: **9600**  
Data Bits: **8**  
Parity: **None**  
Stop Bits: **1**

Note that the Hydro-Control IV printer driver does not use handshaking signals.

## 11.4 Connecting a PLC / Batch controller

Connect the communications port of the PLC / Batch controller to the RS232 socket on the back of the Hydro Control IV operator terminal using the following wiring diagram:

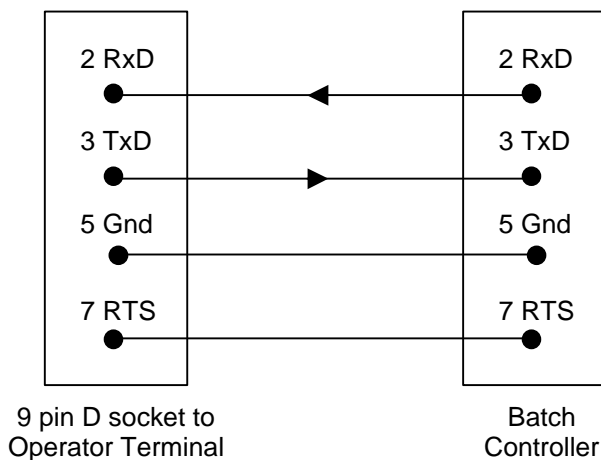

**Figure 20 - RS232 connections for PLC / Batch controller**

The RS232 interface must be set to operate as follows:

Baud Rate:	<b>9600</b>
Data Bits:	<b>8</b>
Parity:	<b>None</b>
Stop Bits:	<b>1</b>

## 11.5 Remote operation using a PLC/batch controller

### Setting up the Mixer Control Set-up

In order for the Hydro Control IV to accept remote commands, the *Mixer Control Set-up* menu **must** be configured so that the option "Recipe number source" is set to **RS232**. If it is not, then the remote command will be rejected when an attempt is made to use it.

When the unit is configured for remote operation, any attempt to change the "Recipe number source" from the operator terminal front panel will be rejected with an error message.

## Sending remote commands

This section describes the commands that the PLC/batch controller must send to the Hydro Control IV to instruct it to carry out the required operations.

It is advisable that remote commands are issued before the start of each mix cycle since remote settings are NOT maintained through power on/off cycles.

**Note:** All commands are terminated with a 'Carriage return' code, ASCII 13.

### Selecting recipes

To select a recipe, send a message in the form:

Start sequence	Mixer number	Equals	Recipe	Terminator
>R	1	=	nnn	ASCII 13

For example, to select recipe 100 from the next *Start Mix* signal

Send the ASCII string **>R1=100**

The remote computer link should ensure that the command has been accepted before activating the *Start Mix* signal.

### Setting dry weights

To set the dry weight, send a message in the form:

Start sequence	Mixer number	Equals	Weight	Terminator
>D	1	=	nnnn	ASCII 13

For example, to select a dry weight of 2027Kg from the next *Start Mix* signal:

Send the ASCII string **>D1=2027**

Sending this command will NOT change the *dry weight* value in the relevant recipe.

The remote computer link should ensure that the command has completed correctly before activating the *Start Mix* signal.

### Adjusting automatic moisture set-point

To set the Auto % target, send a message in the form:

Start sequence	Mixer number	Equals	%	Terminator
>M	1	=	nnn.n	ASCII 13

For example, to set the auto % target to 12.7%:

Send the ASCII string **>M1=12.7**

This value can be either a whole number (positive or negative) or set to one decimal place.

This command will only have an effect if the mixer is set to *Automatic* water addition mode. Sending this command will NOT change the *Auto %* value in the relevant recipe.

The remote computer link should ensure that the command has completed correctly before activating the *Start Mix* signal.

## Adjusting Pre-set water set-point

To set the pre-set water target, send a message in the form:

Start sequence	Mixer number	Equals	Water	Terminator
>P	1	=	nnn.n	ASCII 13

For example to set the pre-set water target to 120.5 litres:

Send the ASCII string **>P1=120.5**

This value can be a whole number or set to one decimal place.

This command will only have an effect if the mixer is set to *Pre-set water* addition mode. Sending this command will NOT change the *Pre-set water* value in the relevant recipe.

The remote computer link should ensure that the command has completed correctly before activating the *Start Mix* signal.

## Adjusting water trim

To set the water trim value, send a message in the form:

Start sequence	Mixer number	Equals	Trim	Terminator
>T	1	=	nnn.n	ASCII 13

For example, to set the water trim to 10.5 litres:

Send the ASCII string **>T1=10.5**

This value can be a whole number or set to one decimal place.

This command will only have an effect if the mixer is set to *Automatic* water addition mode. Sending this command will NOT change the *trim* value in the relevant recipe.

The remote computer link should ensure that the command has completed correctly before activating the *Start Mix* signal.

## Reading the mix log

The most recent record in the mix log can be read by sending a message in the form:

Start sequence	Terminator
*1	ASCII 13

The Hydro-Control IV will reply with a mix log record in comma-separated-variable (csv) form as follows:

rrr	Recipe number
bbbb	Batch count
aaaa	Aggregate weight
ttt.t	Auto water target from recipe
mmmm	Water mode (1 = pre-set, 2 = automatic)
aaa.a	Total water added
ddd.d	Dry mix moisture content.
www.w	Wet mix moisture content.
cc.cc	Water/cement ratio.

ttt.t	Operator water trim.
eee.e	Water error.
hhh.h	Water added by hand.
www.w	2nd shot water.
dddd	Dry mixing time.
www	Wet mixing time.
www	2nd wet mix time.
ttt	Total mixing time.
ffff FFFFF	Decimal numbers representing alarms and other events that occurred in the mix.

The flags field fffff is a decimal number with values as follows...

1	Cement time-out
2	Admix 1 time-out
4	Admix 2 time-out
8	Mix cycle aborted
16	No water required
32	Reduced admix 1 rinse water
64	No admix 1 rinse water
128	Wet mix accepted
256	Wet mix rejected
512	Dry mix accepted
1024	Dry mix rejected
2048	Water meter fault
4096	Stable X1
8192	Stable X2
16384	Stable X3

The flags field FFFFFF is a decimal number with values as follows:

1	Dry mix time limit exceeded.
2	Wet mix time limit exceeded.
4	Wet mix 2 time limit exceeded.
8	Correction wet mix time limit exceeded.

### Reading the current moisture value

The current moisture value can be read by sending a message in the form:

Start sequence	Terminator
*2	ASCII 13

The reply gives the current moisture content, the un-scaled input, and the sensor alarm flags in the form:

-nn.nn,-ll.ll,-ffff

Where...

nn.nn	is the instantaneous moisture value.
ll.ll	is the instantaneous unscaled moisture value.
ffff	is a series of status flags including sensor fault alarms.

## Reading the software version string

The software version identification string (as used at start up) can be accessed by sending a message in the form:

Start sequence	Terminator
*3	ASCII 13

The reply is the ASCII version string displayed at start-up.

## Recipe parameter read/write

Recipe parameters can be changed by specifying the recipe number (1-200), the parameter number (1-23, see table below) and an integer value (-9999 to 9999, see table below for units). See later for return values.

The write command format is:

**# R recipe parameter value <cr>**

The read command format is:

**# R recipe parameter <cr>**

Parameter	Description	Units
1	Dry weight of aggregates (kg)	1
2	Weight of cement in mix (kg)	1
3	Pre wet water (L)	0.1
4	Pre wet mixing time (s)	1
5	Cement call enable (0=off, 1=on)	1
6	Preset water in (L)	0.1
7	Automatic water (%)	0.1
8	Water trim in (L)	0.1
9	Max limit for auto water (%)	0.1
10	Dry mix time (s)	1
11	Admix 1 call enabled (0=off, 1=on)	1
12	Admix 2 call enabled (0=off, 1=on)	1
13	Wet mix time (s)	1
14	Positive tolerance limit (%)	0.1
15	Negative tolerance limit (%)	0.1
16	Batch count	1
17	x1 Sensor scaling value – dry mix (%)	0.01
18	y1 Sensor scaling value – dry mix (%)	0.01
19	x2 Sensor scaling value – wet mix (%)	0.01
20	y2 Sensor scaling value – wet mix (%)	0.01
21	x3 Sensor scaling value – wet mix + additive (%)	0.01
22	y3 Sensor scaling value – wet mix + additive (%)	0.01
23	Auto enable flag (0=pre-set mode only, 1=auto or pre-set mode allowed). Essentially, this means that the calibration data stored in parameters 17 through 22 is valid.	1

## Read mix log record

The mix log can be read by specifying the record number (1-100) and the parameter number (1-32, see table below). See later for return values.

The command format is:

**# M recipe parameter <cr>**

Parameter	Description	Units
1	Day	1
2	Month	1
3	Year	1
4	Hour	1
5	Minute	1
6	Recipe number used	1
7	Batch counter number	1
8	Water method used (1=preset, 2=auto)	1
9	Operator trim level used (L)	0.1
10	Dry weight of aggs used (kg)	1
11	Water target (L)	0.1
12	Water added during control phase (L)	0.1
13	Water added during control phase excluding any admix rinse (L)	0.1
14	Second water added in two-shot mode (L)	0.1
15	Water added in error during control phase (L)	0.1
16	Water added in hand mode during control phase (L)	0.1
17	Water to cement ratio	0.01
18	Auto target in recipe (%)	0.1
19	Dry moisture (%)	0.01
20	Final moisture (%)	0.01
21	Dry mixing time (s)	1
22	Wet mixing time (s)	1
23	2 <sup>nd</sup> wet mixing time (s)	1
24	Total mixing time (s)	1
25	Alarm flags 1 during mix	1
26	Alarm flags 2 during mix	1
27	x1,LNow value at end of dry mix	0.01
28	x2,LNow value at end of wet mix – water only	0.01
29	x3,LNow value at end of wet mix – with admix	0.01
30	dm12, Change in moisture content from main water (%)	0.01
31	dm13, Change in moisture content from total water (%)	0.01
32	Valid mix record flag (0=invalid, 1=valid)  This means that the data contained in this record can be used for calibration purposes i.e. the mix sequence completed normally and the unscaled inputs (Lnow) were from stable readings.	1

To find the number of records in the mix log use the read mix log command with no parameters.

## Global water addition mode

The write command format is:

**# W value <cr>**

Value	Mode
1	Preset
2	Auto

To read the current mode use the command with no parameters.

See later for return values.

Reset all recipes to pre-set mode

The command format is:

**# P <cr>**

## Replying to remote commands

### Return values

The Hydro Control IV replies to all commands with one of the following possible responses:

Value	Meaning
-9999 to 9999	Parameter value as an integer, or 00 to indicate successful completion of a command
?10	Invalid command
?11	Parameter 1 out of range
?12	Parameter 2 out of range
?13	Parameter 3 out of range

## Command acknowledgements

The Hydro-Control will reply to remote commands in the following way:

Code	Meaning
00	Message processed without error.
02	Incorrect format to command and/or data.
03	Unrecognised command.
99	Unable to process command. Probably due to the parameter being out of range or the system not being configured for this command.

The system will not reply unless the start sequence and mixer number is correct. This is for backward compatibility with previous versions of the Hydro-Control system - the Hydro-Control IV system will only respond to a mixer number of 1.



This chapter describes how to backup and restore all the information in the Hydro Control IV using a personal computer.

This facility has been provided to assist in the commissioning and maintenance of the Hydro Control IV system by restoring a terminal to a default configuration that may be different from our factory defaults.

## 12.1 Hydro Control IV Backup/Restore Utilities

The backup/restore utilities are designed for MS-DOS and so will work with most PCs used in the field.

There are two versions of the utilities, namely V1.0 and V1.1.

If your Hydrocontrol firmware is release 2.42 or lower use V1.0 of these utilities. If your firmware is release 2.43 or higher use V 1.1 since these later versions use a different organisation of the internal storage.

Both versions of these utilities are available on floppy disk from Hydronix or can be downloaded from the Hydronix web page : -

[www.hydronix.com](http://www.hydronix.com).

You will find the utilities under the downloads section, HC IV.

## 12.2 Connecting the PC

The utilities use the Hydro Control IV RS232 serial port and you will need the appropriate connecting cable as described below.

Connect COM port 1 of the PC to the RS232 socket on the rear of the Hydro Control IV operator panel using the following wiring diagram:

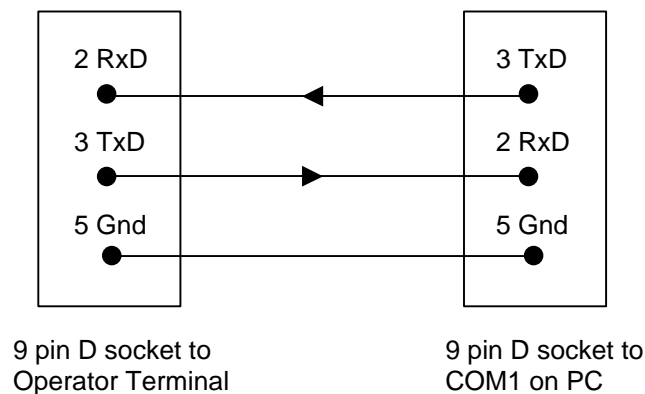

**Figure 21 - RS232 connections for PC**

## 12.3 Downloading the utilities

Create a new directory on your local hard disk called **"UTILITIES"**.

Download the Hydro Control IV utilities from the HYDRONIX web page into the utilities directory you have just created. These can be found under the Technical Support section for Hydro Control IV or can be obtained from Hydronix on floppy disk.

## 12.4 Testing communication

In order to test the communications between your PC and the Hydro Control IV the PC must first be set up as a Hyper Terminal.

To set up the Hyper Terminal program

1. On your PC start the communications software Hyper Terminal found under the path:

**START >-- Programs >-- Accessories >-- Communications >-- HyperTerminal**

2. The program asks you to give the new connection a name and connection details. Enter the following:

NAME: **HC IV**  
CONNECT USING: **Direct to COM1**

3. Now enter the PORT SETTINGS as follows:

Bits Per Second: **9600**  
Data Bits: **8**  
Parity: **None**  
Stop Bits: **1**  
Flow Control: **None**

Click on the OK button to accept these settings.

4. When the HC IV connection page is displayed, adjust the properties as follows:

From the Menu Bar select: **FILE >-- PROPERTIES**

Click on the Settings Tab followed by the ASCII Set-up button.

Check the box marked "Echo Typed Characters Locally".

Click on the OK button and then again to accept these changes.

To test the communications

The PC is now ready to test communication with the Hydro Control IV operator terminal.

1. Log into the Hydro Control IV using the code: **141421**.
2. Go to the Main Menu screen and select Mixer Control Set-up.
3. Set the RS232 Port Usage to REMOTE LINK.
4. Return to the Main Menu screen and select RS232 Diagnostic. This will enable you to monitor instructions sent from the PC using HyperTerminal.

5. On the PC HyperTerminal Screen type:  
     \*1 and press **ENTER**.
6. The PC screen will display a list of the most recent record in the mix log in numerical form (further info can be found in the Hydro-Control IV User Guide in the section on RS232 Computer Link Protocol).
7. On the RS232 Diagnostic screen on the Hydro-Control IV check that beneath Rx buffer it displays:  
     \*1

If the above results are correct then the communications between the PC and the Hydro-Control are functioning correctly and it will be possible to use the Backup/Restore utilities.

## 12.5 Using the Backup/Restore utilities

### **Important!**

When the Backup/Restore mode is selected, the Hydro Control IV system is effectively taken “off-line” and cannot be used to control the mixing cycle. Once backup/restore operations have been completed, you must power up the unit to restore normal operation.

### To Backup

1. On the Hydro-Control IV log into the operator panel using the code: **31415**
2. From the Main Menu screen select: **Backup/restore**  
     The screen will display “**Backup/restore**” and can only be reset by switching off power to the unit.
3. Shut down the HyperTerminal program on the PC and select the **MSDOS** prompt from within Windows.
4. At the prompt **C:\WINDOWS** type **cd c:\utilities** and press **ENTER**.
5. The Syntax for the Backup utility is: **Backup <directory> <port>**  
     where <Directory> is the path name of the directory where the files are to be stored and <port> is the number of the COM port being used.
6. For example: **Backup backuplog 1** followed by **ENTER**  
     The screen will display: **HC4 Backup V1.1 (or V1.0 if being used)**  
     **Using COM 1**  
     **Receiving Data 1**
7. The program will seem to have stopped at this point but is actually still functioning as long as no error messages appear. The Backup will continue until the message “**Successful Backup**” appears.

Return to windows and look in the directory “**UTILITIES**”. There should be a sub folder called “**backuplog**” containing the Data from the Hydro-Control IV; this can be used to restore the Hydro-Control IV when necessary using the Restore function.

## To Restore

1. On the Hydro-Control IV log into the operator panel using the code: **31415**
2. From the Main Menu screen select: **Backup/restore**  
  
The screen will display “**Backup/restore**” and can only be reset by switching off power to the unit.
3. Shut down the HyperTerminal program on the PC and select the **MSDOS** prompt from within Windows.
4. At the prompt **C:\ WINDOWS** type **cd c:\utilities** and press **ENTER**.
5. The Syntax for the restore utility is: **Restore <directory> <port>**

Where <Directory> is the path name of the directory where the files are stored and <port> is the number of the COM port being used.

The information will then be transferred to the Hydro Control IV and a completion message will appear.

## To capture mix-log data

The current contents of the mix log can now be captured to a PC using the **mixlog** utility. This may be used at any time and does not require the Hydro Control IV to be taken off-line; however, it does require the RS232 port to be set to Remote Link.

The command syntax is: **mixlog <filename><port>**

Where <filename> is the name of the file on the PC where the data is to be saved and <port> is the number of the COM port being used.

The data is saved in a comma-separated-variable format that can be imported by most popular spreadsheet programs.

This chapter describes some basic maintenance procedures that may need to be carried out on the Hydro Control IV.

### 13.1 Anti-static handling

This equipment contains devices that could be damaged in the event of a static electricity being discharged through them. At all times please observe anti-static precautions when handling the main PCB and always carry out the procedures in an anti-static working area.

### 13.2 EPROM replacement

The following procedure describes how to replace the EPROM on the main PCB:

1. Undo the four crosshead screws securing the rear cover plate on the operator terminal.
2. Carefully remove the rear cover.
3. Remove the EPROM (IC11) using a recognised IC removal tool.
4. Fit the new EPROM using a recognised IC insertion tool and ensuring that the EPROM is in the correct orientation. The correct orientation is with the indent on the IC at the end nearest connector J1 (see Figure 21).

### 13.3 Battery replacement

The following procedure describes how to replace the battery on the Hydro Control IV:

1. Undo the four crosshead screws securing the rear cover plate on the operator terminal.
2. Carefully remove the rear cover.
3. Disconnect the following cables from the main PCB:
  - J1, J2, J8, J9
  - J10 (2 purple wires to fascia plate buzzer)
  - J6, part cable at blue connector, note the orientation of the cable from the main display.
4. Undo the 4 crosshead screws securing the main PCB to the chassis and carefully lift the main PCB clear.
5. De-solder the 3 pins securing the battery to the main PCB and lift clear.
6. Solder the new battery into the main PCB.
7. Refit the main PCB into the chassis.
8. Reconnect the cables removed in step 3 ensuring orientation of cable J6 is correct.
9. Refit the rear cover to the operator terminal.
10. After switching on mains power, allow sufficient time for battery to charge.

Dispose of battery according to manufacturers recommendations (normally supplied with the battery).

## 13.4 Fuses

The operator terminal is protected internally by three thermal resettable fuses. These may be reset by removing the fault condition and the supply voltage.

Fuse	Rating	Circuit
FS1	500mA	+15V sensor supply
FS2	500mA	+24V internal supply for I/O and analogue output
FS3	500mA	Relay output common

All fuses are located on the main circuit board as indicated in Figure 22.

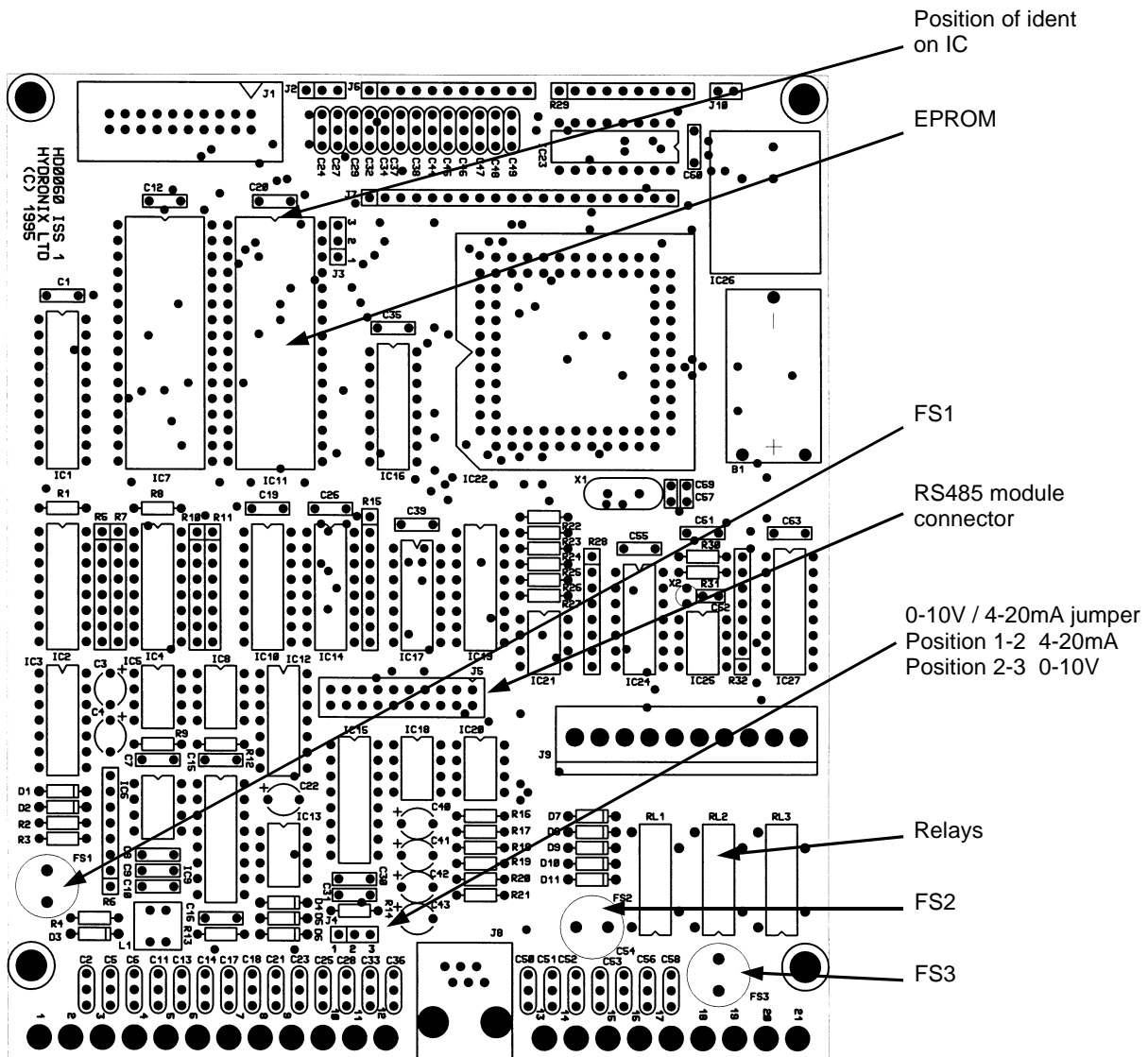

Figure 22 - Operator terminal main circuit board

## PERFORMANCE

Percentage moisture range:	0 – 20%
Accuracy:	0.1%
Synchronised sensor reading:	3 methods of filtering sensor signal to eliminate effect of air pockets during mixing
Mix data log:	Records data from last 100 mixes
Error analysis:	Graphical display of deviation from target of last 100 mixes

## ELECTRICAL

Mains supply voltage:	100/110/230V ac, 50/60 Hz
Power rating:	12W max (Operator terminal) 6W max (Input/output unit)

## MECHANICAL

Dimensions (width x height x depth)

Operator terminal (panel mounted):	220mm x 230mm x 120mm max (including connectors)
Panel aperture:	202mm x 212mm
Steel enclosure:	480mm x 360mm x 240mm
Input/output module:	395mm x 110mm x 100mm max (including DIN rail mounting)

Weight

Operator terminal:	4kg
Steel enclosure:	13kg
Input/output module:	1kg

## ENVIRONMENT

Temperature range:	5 – 40 °C
Relative humidity:	80% at 31 °C derating linearly to 50% at 40 °C
Altitude:	200m max
Environmental rating:	IP54
Safety approval:	IEC 664 Installation category II, pollution degree 2
Insulation Class:	
Operator terminal:	Class 1
Input/output rack:	Provides BASIC insulation only

This unit must be installed in an enclosure, which provides additional protection in the advent of a single fault through either:

- Use of a protective ground conductor
- Supplementary, double or reinforced insulation

Wall mounted enclosure: When installed in the wall-mounted enclosure, the Hydro Control IV system is insulation CLASS 1

## INPUTS

Sensor inputs:	1 x Hydro-mix microwave sensor
Analogue input:	1
Digital inputs:	7
Voltage:	Specified by customer (typically 10–32V AC/Dc or 9-140V AC/DC or 180-280V AC/DC)

## OUTPUTS

Digital outputs:	9
Voltage:	Specified by customer (typically 10–32V AC/Dc or 9-140V AC/DC or 180-280V AC/DC)

## COMMUNICATIONS

RS485 interface:	1 port for connecting to batch controller
RS232 interface:	1 port for connecting to printer or computer
Baud rate:	<b>9600</b>
Data bits:	<b>8</b>
Stop bits:	<b>1</b>
Parity:	<b>None</b>

## ALARMS AND SECURITY

Total number of alarms:	19
Alarm configuration:	User configured for silent or with siren
Alarm log:	Displays last 100 alarm occurrences
Security:	Four levels of access to system depending on user code

## GENERAL

Maximum number of recipes:	200
Keyboard:	Sheet keyboard with polyester overlay
Graphic display:	240mm x 128mm graphics module with backlighting
Languages:	English, French, German, Japanese, Spanish, Italian, Dutch, US Customary, Alphanumeric, Polish
Measurement units:	Metric or US customary (if selected)



When installed and operated according to the instructions given in this guide, this equipment conforms to the requirements of Council Directive 89/336/EEC according to the following schedule:

Equipment type:	Hydro-Control IV Operator terminal unit model number HC04 (revision D or later)	
Manufacture:	Hydronix Ltd, 7 Riverside Business Centre, Walnut Tree Close, Guildford, Surrey, England	
Conformity criteria:	<i>Conducted emissions:</i>	EN55011:1991 Group 1 Class A
	<i>Radiated emissions:</i>	EN55011:1991 Group 1 Class A
	<i>Radiated immunity:</i>	prEN50082-2:1992
	<i>Electrostatic discharge:</i>	prEN50082-2:1992
	<i>Fast transient/burst immunity:</i>	prEN50082-2:1992

### Automatic control sequence

The diagram below is an overview of the Hydro-Control IV automatic control sequence and shows how the system operates based on the states of the digital inputs. It does not show all of the detailed decisions and in particular excludes actions taken on input time-outs that, in most cases, are configurable.

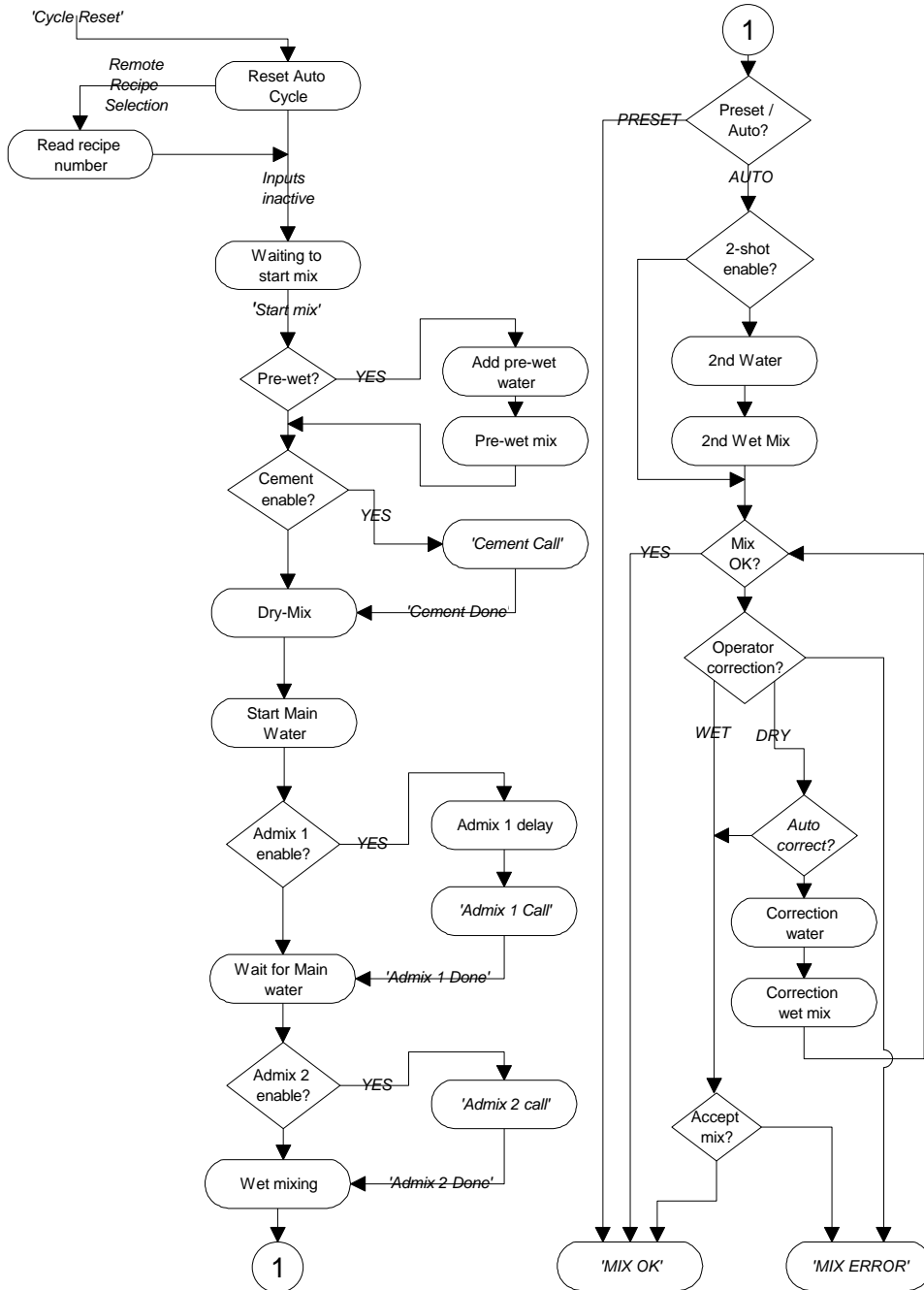



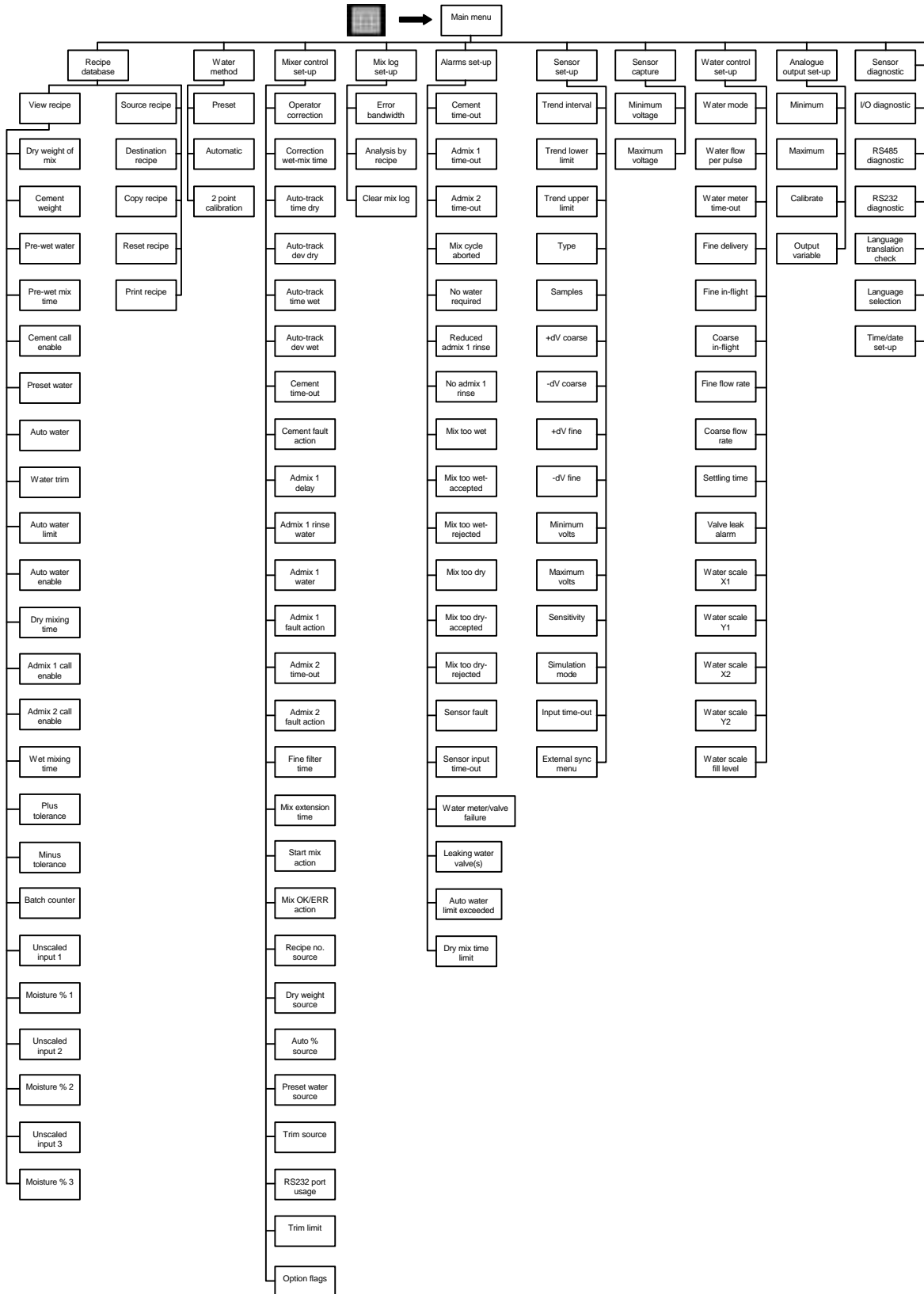

## Basic Mix cycle timing

The Hydro Control IV will perform various functions according to the settings in the Recipe Database and input signals from the control system. The Status Display will show a graph of the moisture on the Trend display and the current mix cycle status on the Status line.

A basic mix cycle is described below.

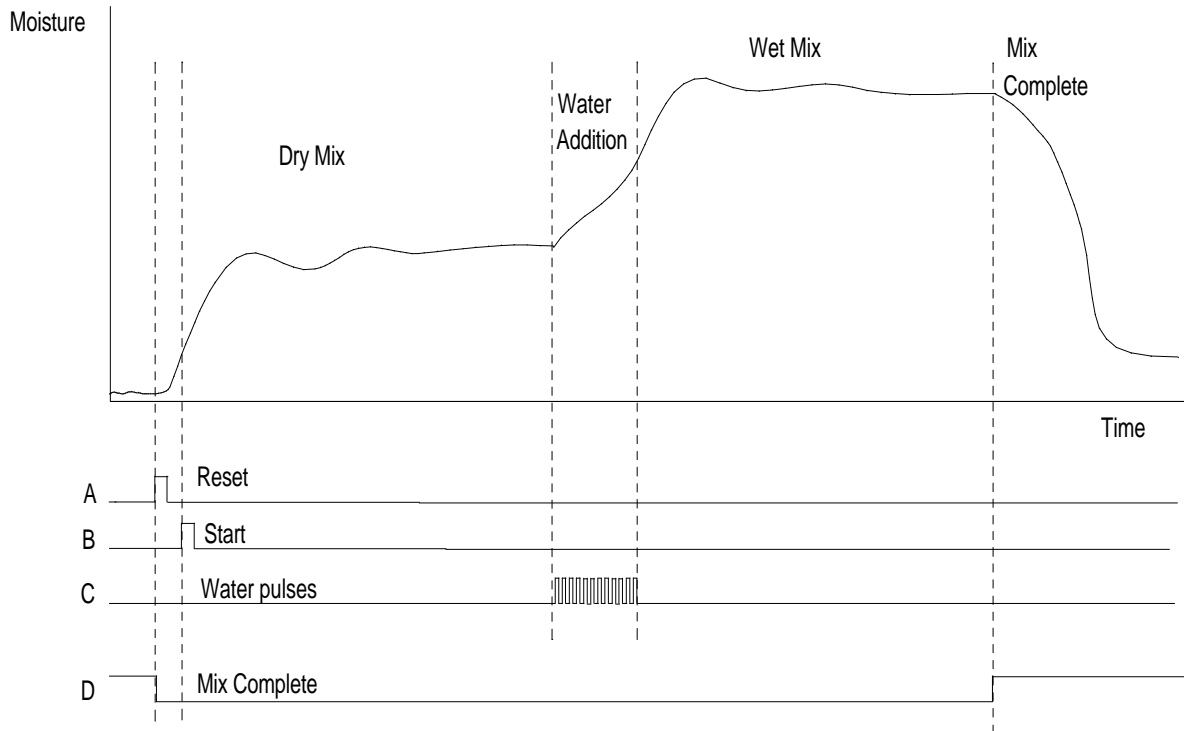

**Figure 23 - Basic Mix Cycle Timing**

**A Reset.** An input signal of at least one second is required. The Hydro Control IV will reset. Once the reset signal is removed, the new Recipe Number for the next mix will be accepted from either the RS232, Remote Recipe Rack or Keypad depending on the system configuration.

**B Start.** An input signal of at least one second is required with at least a one second interval after the Reset signal is removed. This signal is normally sent to the Hydro Control IV after all the aggregates and cement have been charged into the mixer.

The Hydro Control IV will start the Dry Mix cycle, at the end of which and provided a stable signal is captured, the Water Required will be calculated.

**C Adding Main Water** The Hydro Control IV will open the water valve to add the correct water. The Status display will show how much water is being added as water meter pulses are received from the water meter. When the correct water has been added the Hydro Control IV will start the Wet Mix cycle, at the end of which the final moisture will be compared against limits in the Recipe database and the Mix Complete signal output to the control system.

**D Mix Complete** The mix complete signal is sent to the control system indicating that the mixer can be discharged. The control system may also interrogate the Mix OK and Alarm signals at this time.

## Mix cycle timing using the majority of Inputs and Outputs

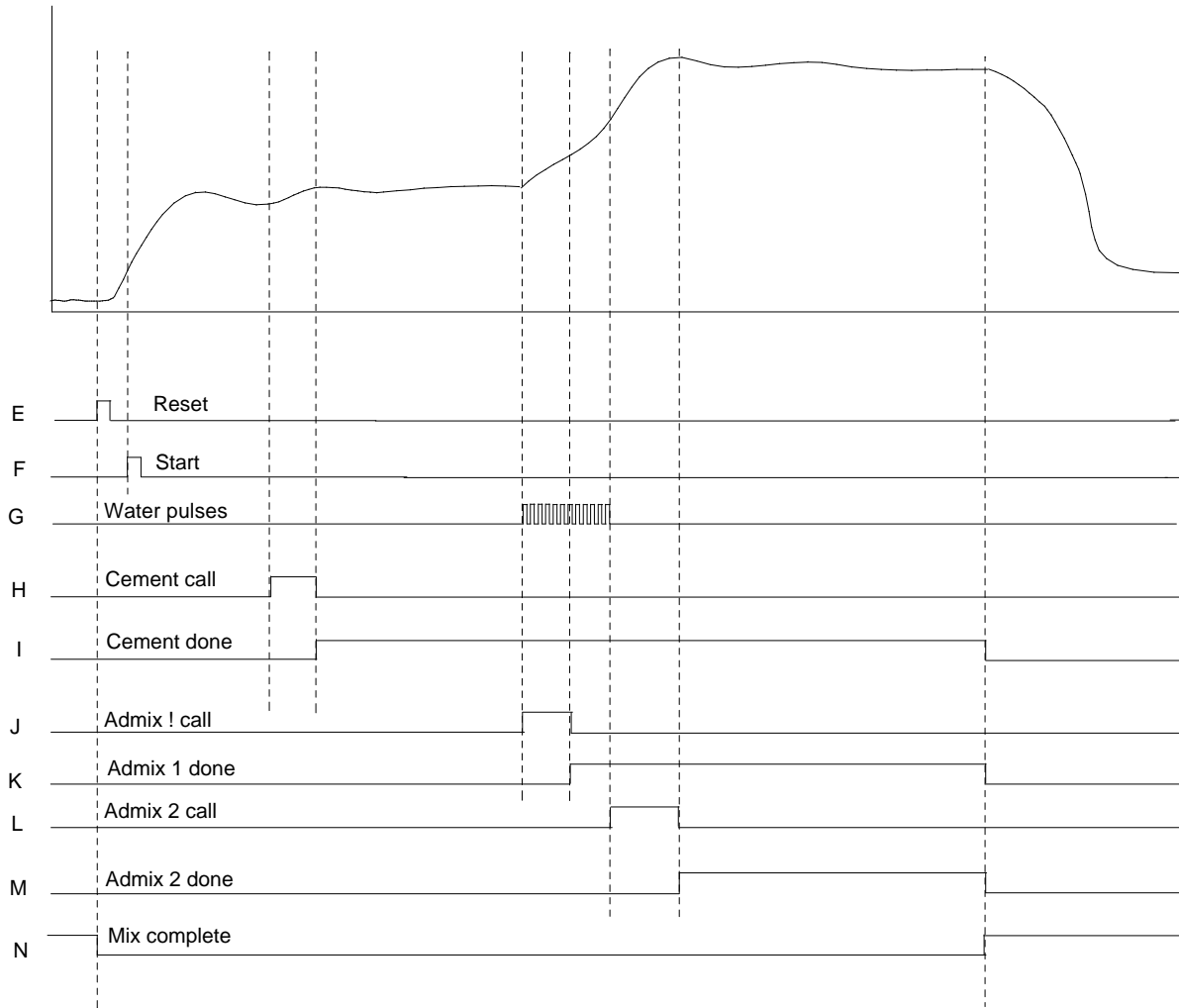

**Figure 24 - A more complicated mix cycle using the majority of Inputs and Outputs**

This timing diagram shows the use of the majority of input and output modules and when they are active during the mix cycle.

Each input and outputs function is described below.

**E, F, G & N** operate as **A, B, C & D** in Figure 22 above.

**H** Cement Call, Output, indicates to the control system when to add the cement, normally used in conjunction with Pre-wet water.

**I** Cement done, Input, indicating all the cement has been added to the mix.

**J** Admix 1 call, Output, indicates when to add Admix 1 to the mixer during the water addition.

**K** Admix 1 done, Input, indicates that all the admix has been added to the mix.

**L** Admix 2 call, Output, indicates when to add Admix 1 to the mixer during the wet mix cycle.

**M** Admix 2 done, Input, indicates that all the admix 2 has been added to the mix.

## Factory test display

The Hydro Control IV includes a factory test display page to assist in troubleshooting if problems are suspected with the operator interface. This requires a special user code of 31415 and, once selected, it is necessary to remove power from the Hydro Control IV to restore normal operation.

Since this function exercises the inputs and outputs of the Hydro Control IV, it is not recommended that it is used when the instrument is connected to the plant.

The test page performs the following operations:

- Displays the voltage at the sensor input.
- Cycles the voltage/current on the analogue output between 0, 50% and full scale.
- Operates each output relay in turn.
- Performs an external loop-back test on the serial port. You must connect transmit data to receive data to see this.
- Displays the state of the digital inputs.

### To use the factory test display

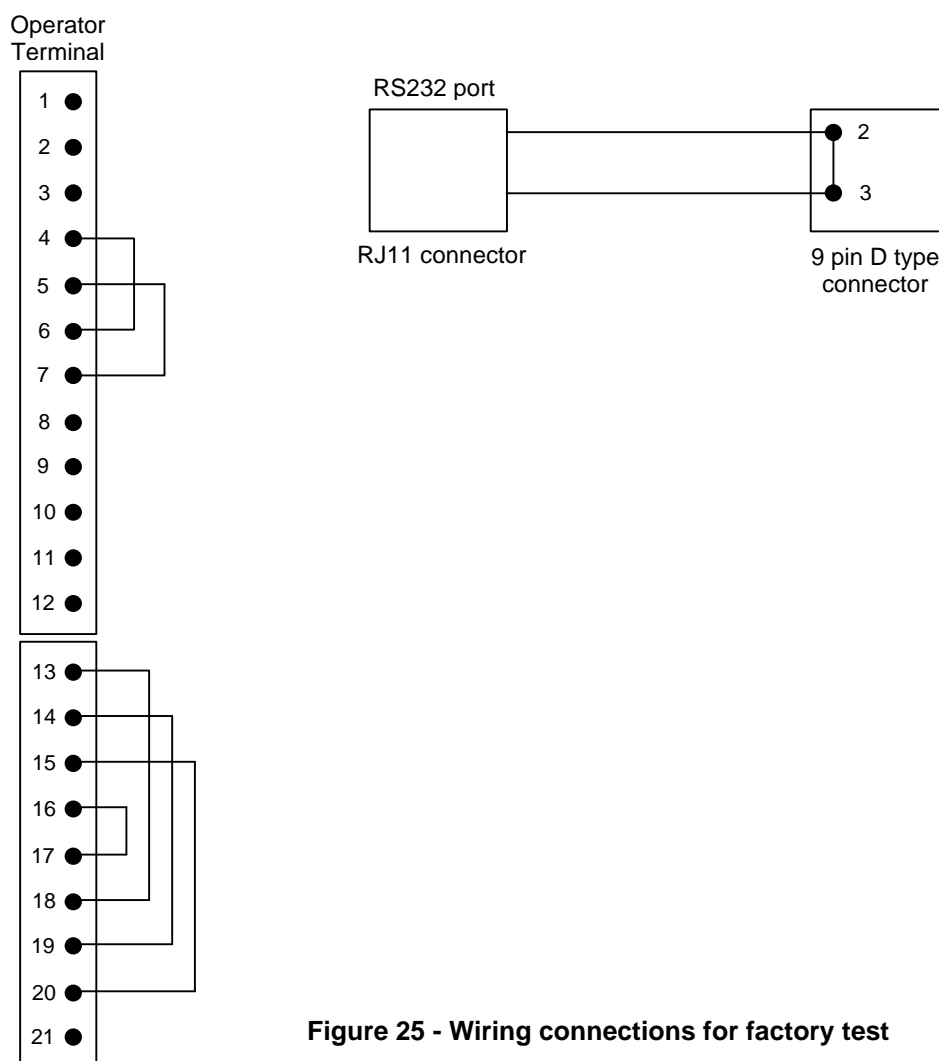

**Figure 25 - Wiring connections for factory test**

1. Disconnect the Hydro Control IV from the power supply.
2. Disconnect all wires connected to the Hydro Control IV after first noting their positions.
3. Connect jumpers in the positions shown in Figure xx. If you wish to test the RS232 port, you will need to use a RJ11 to 9-pin D-type connecting cable available from Hydronix.
4. Re-apply power and enter user code 31415.
5. Select menu option "Factory Test" from Main Menu.

If the Hydro Control IV is working correctly, the display will show:

- Analogue output voltage (OUT) will cycle between 0, 5 and 10V.
- Sensor input voltage (IN) will cycle between 0, 5 and 10V at the same time as the output voltage due to the feedback wiring.
- Output relays (out) 1, 2 and 3 will cycle in a binary sequence:
- Digital input signals (in) 1 and 2 are connected back to relays 1 and 2 and will therefore follow the pattern above.
- Battery (Batt) will display 1 if the internal Lithium battery is healthy, otherwise it will display 0.
- Key will display the name of the relevant key when pressed.
- RS232 (232) will scroll, "The quick brown fox jumps over the lazy dog".

Contact your distributor for further details if any of the above fails to operate correctly.



These tables have been provided for recording your working values after system commissioning has been complete. Please fill them in and keep them up-to-date with your system documentation.

### Mixer control set-up

Parameter	Units	Default	As Used
Operator correction	None	1	
Correction wet-mix time	%	50	
Auto-track time dry	s	10	
Auto-track dev. dry	Moisture %	0.10	
Auto-track time wet	s	10	
Auto-track dev. wet	Moisture %	0.10	
Cement time-out	s	30	
Cement fault action	None	Wait	
Admix 1 delay	s	0	
Admix 1 rinse water	L	0.0	
Admix 1 time-out	s	30	
Admix 1 fault action	None	Wait	
Admix 2 time-out	s	30	
Admix 2 fault action	None	Wait	
Fine filter time	s	10	
Mix extension time	s	20	
Start-mix action	None	Continue	
Mix OK/ERR action	None	01 / 10	
Recipe number source	None	Keypad	
Dry weight source	None	Recipe	
Auto % source	None	Recipe	
Pre-set water source	None	Keypad	
Trim source	None	Keypad	
RS232 port usage	None	Printer	
Trim limit (+/-)	L	10.0	
Option flags	None	00000100	

**Note:** Water method defaults to Preset

### Mix log set-up

Parameter	Units	Default	As used
Error bandwidth	%	0.5	
Analysis by recipe	None	1	
Clear mix log	None	---	

## Sensor set-up

Parameter	Units	Default	As used
Trend interval	s	1.0	
Trend lower limit	%	0.00	
Trend upper limit	%	10.00	
Type	None	1	
Samples	None	100	
+dV Coarse	Volts	0.03	
-dV Coarse	Volts	0.06	
+dV Fine	Volts	0.01	
-dV Fine	Volts	0.04	
Minimum volts	Volts	0.5	
Maximum volts	Volts	11.0	
Sensitivity	mV	10	
Simulation mode	None	0	
Input time-out	s	5	
External sync menu	-	-	

## Water control set-up

Parameter	Units	Default	As used
Water mode	None	Metered	
Water flow per pulse	Litre	1.00	
Water meter time-out	s	5	
Fine delivery	L	0.0	
Fine in-flight	L	0.0	
Coarse in-flight	L	0.0	
Fine flow rate	L/s	0.1	
Coarse flow rate	L/s	1.0	
Settling time	s	1	
Valve leak alarm	L	2.0	
Water scale X1	%fsd	0.0	
Water scale Y1	Kg	0.0	
Water scale X2	%fsd	100	
Water scale Y2	Kg	200	
Water scale fill level	Kg	100.0	

## Analogue output set-up

Parameter	Units	Default	As used
Minimum	%	0.00	
Maximum	%	20.00	
Calibrate	%	20.00	
Output variable	None	Now	

## Appendix H Installation / commissioning checklists

### Installation Checklist

Item	OK	Notes
Mounting	<input type="checkbox"/>	
Power supply rating and indication	<input type="checkbox"/>	
Hydro-Mix sensor installation	<input type="checkbox"/>	
Hydro-Mix sensor connections	<input type="checkbox"/>	
Sensor earthing and cable shield	<input type="checkbox"/>	
Synchronisation input	<input type="checkbox"/>	
Input/output unit wiring	<input type="checkbox"/>	
Input/output unit switches	<input type="checkbox"/>	
Input/output unit modules	<input type="checkbox"/>	
Remote recipe unit wiring	<input type="checkbox"/>	
Remote recipe unit switches	<input type="checkbox"/>	
Remote recipe unit modules	<input type="checkbox"/>	
RS485 cable	<input type="checkbox"/>	
Printer / Computer cable	<input type="checkbox"/>	
Signed:..... Date:.....  System identification:.....		

## Commissioning checklist

Item	OK	Notes
Installation complete	<input type="checkbox"/>	
Language selection	<input type="checkbox"/>	
Input/output communications	<input type="checkbox"/>	
Input/output operation	<input type="checkbox"/>	
Hand mode controls	<input type="checkbox"/>	
<i>Mixer control set-up</i> menu	<input type="checkbox"/>	
Remote recipe selection	<input type="checkbox"/>	
RS232 interface	<input type="checkbox"/>	
Pre-set water mode operation	<input type="checkbox"/>	
Sensor operating parameters	<input type="checkbox"/>	
Auto-track facility	<input type="checkbox"/>	
Mix tolerances	<input type="checkbox"/>	
Calibration	<input type="checkbox"/>	
Automatic water mode	<input type="checkbox"/>	
Printer operation	<input type="checkbox"/>	
Record system configuration	<input type="checkbox"/>	
Signed:..... Date:.....		
System identification:.....		

## OPTO-22 input/output modules configuration

Use the table below to record the digital input/output modules fitted to your Hydro-Control IV system for future reference:

### Digital input module types

No.	Description	G4SWIN	G4IDC5	G4IDC5K	G4IAC5	G4IAC5A
1	Water pulse					
2	Start mix					
3	Cycle reset					
4	Cement done					
5	Admix 1 done					
6	Admix 2 done					
7	Reserved					
---	Spares					
---	Total					

### Digital output module types

No.	Description	G4SWOUT	G4ODC5	G4OAC5	G4OAC5A
8	Fill water				
9	Coarse water				
10	Fine water				
11	Cement call				
12	Admix 1 call				
13	Admix 2 call				
14	Mix complete				
15	Mix OK/ERR				
16	Alarm				
---	Spares				
---	Total				

### Analogue input module types

No.	Description	AD3	AD6	AD7	AD9T
An	Water weigh				

Certain operations on the Hydro Control IV have restricted access and may only be executed using the correct user code.

There are four levels of access to the system as shown below with the appropriate user code:

Operator:	<b>No code required</b>
Supervisor:	<b>11111</b>
Engineer	<b>141421</b>
Back-up/Restore:	<b>31415</b>

**You may like to remove this page from the manual for security reasons.**

- Access
  - log in key, 18
  - log out key, 19
  - Logging in/out, 23
- Admix 1
  - call enable, 46
  - delay, 49
  - done, 79
  - fault action, 49
- Admix 2
  - call enable, 47
  - done, 79
  - fault action, 49
- Alarm
  - acknowledgement, 42
  - configuration, 42
- Alarms
  - set-up, 55
- Analogue output set-up, 55
- Auto mode
  - selecting, 38
- Auto water enable, 46
- Auto-correction, 43
- Automatic control sequence, 120
- Auto-track
  - deviation, 98
  - deviation-dry, 49
  - deviation-wet, 49
  - set-up, 98
  - time, 98
  - time-dry, 48
  - time-wet, 49
- Build-up of material, 36, 59
- Calibration, 29
  - 2 point water addition, 33
  - adjusting values manually, 36
  - automatic mode, 35
  - methods, 29
  - preset mode, 30
  - problems, 36
- Cement
  - call enable, 46
  - done, 79
  - fault action, 49
- Coarse water, 89
  - output, 79
- Commissioning
  - checklists, 130
  - system, 85
  - tables, 128
- Computer
  - connecting, 100
  - protocol, 105
- Configuration
  - alarms, 42
  - digital inputs, 79
  - digital outputs, 79
  - menus, 46
  - opto-22 modules, 132
  - recording, 99
  - tables, 128
- Cycle
  - aborting, 45
  - advanced mix timing, 125
  - basic mix timing, 124
  - reset, 79
  - running the mix cycle, 37
  - starting, 37
  - status, 57
- Digipot, 17
- Error bandwidth, 52
- Error distribution
  - display, 61
- Error trend
  - display, 59
- Fault
  - admix 1, 59
  - admix 2, 59
  - cement, 59
  - leaking water valve, 56
  - sensor, 56
- Fill water output, 79
- Fine water
  - output, 79
  - valve, 88
- Fuses, 116
- Input / Output
  - diagnostic, 62
  - module types, 81
  - wiring diagram, 82
- Input / Output unit
  - installation, 76
  - switch settings, 84
- Installation, 66

- troubleshooting, 84
- Introduction, 12
- Keypad functions, 17
- Language
  - selection, 85
  - translation check display, 63
- Lightning
  - protection from, 67
- Manual Mode
  - selecting, 38
- Menu Map, 122
- Mix
  - aborting current cycle, 45
  - too dry, 43
  - too wet, 44
- Mix Complete
  - output, 79
- Mix log
  - display, 58
  - set-up, 52
- Mix OK/ERR
  - description, 51
  - output, 80
- Mixer control
  - set-up, 48
- Mixing times
  - in mix log, 58
  - setting, 98
- Moisture value
  - display, 57
- Operator terminal, 16
  - connecting to I/O unit, 78
  - connecting to RS232, 100
  - connections to panel mounted, 73
  - installation, 68
- OPTO-22, 76
- Printer
  - connecting, 103
- Privileges, 23
- Recipe
  - copying, 28
  - creating/editing, 26
  - database description, 46
  - database examples, 27
  - remote selection, 87
  - remote selection unit, 76
  - select key, 17
  - set-up, 25
  - viewing, 21
- RS232
  - connections, 100, 103, 104, 111
  - diagnostic, 63
  - interface settings, 104
  - interface to batch controller, 87
  - remote operation, 100
- RS485
  - connections, 78
  - diagnostic, 62
  - termination, 78
- Select/Enter key, 17
- Sensor
  - avoiding problems, 74
  - capture display, 64
  - connecting, 73
  - diagnostic, 62
  - principal of operation, 13
  - recommended starting values, 97
  - set-up, 53
  - signal filtering, 92
- Soft key functions, 18
- Start mix
  - input, 79
- Status display, 16, 57
- Tolerances
  - setting, 99
- Trend display, 57
  - adjusting scale, 39
- US Customary, 85
- User codes, 23, 133
- values
  - adjusting, 22
- Water
  - addition record in mix log, 58
  - adjusting preset value, 30
  - auto enable, 46
  - auto target %, 46
  - automatic addition, 39
  - control sequence, 121
  - control set-up, 88
  - meter input, 79
  - preset addition, 39
  - preset mode, 30
  - selecting addition mode, 39
  - trimming automatically, 41
  - trimming manually, 41
  - weighing, 90